



Glasswasher line

Lavabicchieri /

Lave-verres





Make it real with ATA connect

Imagine a Service Partner entering your restaurant and asking you to check your dishwasher, instead of you asking for a visit. Imagine a Service Partner that can fix your dishwasher problem quickly, instead of leaving you alone with your busy restaurant & your dishwashers standing idle, waiting to be fixed. This is now possible with WiFi connected dishwashers.

Rendilo possibile con ATA connect.

Immagina che sia il Tecnico ad entrare nel tuo ristorante e chiederti di controllare la lavastoviglie, invece di essere tu a doverlo chiamare. Immagina che il Tecnico conosca il problema della tua lavastoviglie ancora prima di vederla, e che la possa riparare velocemente, avendo sempre già con sé il ricambio corretto. Ora è possibile con le nostre lavastoviglie WiFi.

Maintenant il est possible avec ATA connect.

Imaginez que votre technicien entre dans votre restaurant et il vous demande de vérifier le lave-vaisselle. Imaginez que le technicien connaisse quel est le souci de votre lave-vaisselle avant même de le voir et qu'il puisse le réparé rapidement. C'est maintenant possible avec nos lave-vaisselles WiFi.

A world of new possibilities to support you /
Le nuove funzionalità al tuo servizio /
Les nouvelles fonctionnalités à votre service



Remote monitoring

Always connected to your Service Partner for your peace of mind.

Controllo da remoto

Sempre connessa al tuo Centro Assistenza, così puoi stare tranquillo.

Télécommande

Toujours connecté à votre centre d'aide pour que vous puissiez vous sentir à l'aise.



Preventive maintenance

Periodic check alert to prevent dishwasher downtime.

Manutenzione preventiva

Segnalazione delle manutenzioni periodiche, per evitare fermi macchina.

Maintenance préventive

Rapport de maintenance périodique, pour éviter les temps d'arrêt de la machine.



Alarm warning

Remote alert notice for faster problem solving.

Invio dei messaggi di errore

Comunicazione dei problemi via WiFi, per una manutenzione più rapida.

Envoi de messages d'erreur

Communication des problèmes via WiFi, pour une maintenance plus rapide.



Remote setting

Faster cycle parameter change. No Service charge.

Programmazione dei cicli da remoto

Modifica dei parametri di lavaggio più veloce ed economica.

Programmation à distance des cycles

Changement plus rapide des paramètres de lavage.

ATA connect

Enjoy the best Service Experience in the market with ATA Connect, our technology combining a WiFi data transmission system to a Service QR code. Your dishwasher is 24/7 connected to your Service Partner, who can control it by remote. He can also receive Alarm alerts in real time, sometimes even before you might be aware of any problem.

The dishwasher can also recommend your Service Partner a preventive service check, when needed. So you can plan it during low workload timing, and reduce the risk of failures when the location is busy.

Not satisfied about the 8 pre-set programs? The dishwasher is not washing well after changing your chemical brand? Not a problem: your Service Manager can change your cycle settings from remote, quickly and without charging the cost of a visit.

You can finally focus on what you care the most: your customers.

Goditi il miglior Servizio di Assistenza Tecnica sul mercato con ATA Connect, il sistema che combina la tecnologia WiFi di trasmissione dati ad un Service QR code. La lavastoviglie è costantemente monitorata da remoto dal tuo tecnico, e gli invia eventuali segnali di errore, a volte persino prima che tu ti sia accorto del problema.

Inoltre consiglia al tecnico quando fare la manutenzione preventiva, così da poterla programmare quando il locale non è aperto al pubblico ed evitare fermi macchina durante il servizio.

Non sei soddisfatto degli 8 cicli di lavaggio pre-impostati? La lavastoviglie non lava più bene dopo aver cambiato la marca di detersivo? Non ti preoccupare: il tuo tecnico potrà cambiare i parametri di ciclo da remoto, velocemente e senza farti pagare l'uscita.

Finalmente puoi concentrarti su quello che ami fare di più: prenderti cura dei tuoi clienti.

Profitez de la meilleure technologie d'assistance technique disponible sur le marché avec ATA Connect, le système combine la transmission de données WiFi à un service de code QR. Le lave-verres est surveillé à distance de votre service technique et envoie des signaux d'erreur, parfois avant que vous même aviez remarqué le souci.

Il indique également au technicien à quel moment effectuer la maintenance préventive, afin de pouvoir la programmer lorsque votre activité n'est pas ouverte au public et d'éviter d'arrêter l'appareil pendant le service.

Pas satisfait des 8 cycles de lavage pré-réglés? Le lave-verres ne lave pas aussi bien après avoir changé la marque de détergent? Ne vous inquiétez pas: votre technicien peut modifier les paramètres du cycle à distance.

Enfin, vous pouvez vous concentrer sur ce que vous aimez le plus: prendre soin de vos clients.



Video available on www.atasrl.com
Video disponibile su www.atasrl.com
Vidéo disponible sur www.atasrl.com

ATA advantages



Auto-clean

An auto-clean cycle can be selected after use to reduce the hassle & cost of manual washing.

Un ciclo di auto-pulizia permette di ridurre il tempo e il costo di pulizia della lavastoviglie.

Un cycle d'autonettoyage réduit le temps et les coûts de nettoyage.



Water softener

Resin regeneration is programmed during washing cycles with our state-of-the-art built in water softener (*models ending with D*). No idle time.

Il nostro addolcitore (modelli che terminano con D) di ultima generazione rigenera le resine durante il ciclo di lavaggio, senza fermi macchina.

Notre adoucisseur (*modèles avec D*) dernière génération régénère les résines pendant le cycle de lavage, sans temps d'arrêt.



Thermolock System

Thermolock system ensures glasses sanitization because the rinsing cycle only starts when water is at 82°C.

Thermolock è il sistema che garantisce la sanitizzazione dei bicchieri, perché non permette di risciacquare se non con acqua ad 82°C.

Le système 'Thermolock' garantit la parfaite hygiène de la vaisselle car le cycle de rinçage commence seulement quand l'eau est à 82°C.



Smart Dispenser

A smart dosing system – available on demand (option) – that "feels" the dirt and pours in only the needed detergent when it is needed.

Sistema di dosaggio intelligente del detersivo (optional), che 'sente' lo sporco e ne immette solo la quantità necessaria.

Système de dosage intelligent de détergent qui capte le degré de la saleté et ne diffuse que la quantité requise.



Cups

Short & energy saving cycle, specific for coffee & milky stains.

Ciclo corto e a basso consumo energetico, specifico per macchie di caffè e latte.

Cycle court et faible consommation d'énergie spécifique pour les taches de café et de lait.



Glasses

Short washing cycle combined to a gentle rinsing, for a perfectly dry & shining result.

Bicchieri asciutti e brillanti con un ciclo di lavaggio corto abbinato a un risciacquo delicato.

Verres séchés et brillants avec un cycle de lavage court combiné à un rinçage doux.



Cutlery

Washed & rinsed at high temperature, cutlery can shine without being deteriorated.

Le posate possono essere lavate ad alte temperature per rimuovere meglio lo sporco, senza deteriorarle.

Les couverts peuvent être lavés à haute température pour mieux enlever la saleté, sans les endommager.



Sanitization

Higher washing temperature and longer washing time can sanitize your crockeries.

Un maggior tempo di lavaggio a temperature più alte per sanitzare le stoviglie.

Un temps de lavage plus long et des températures plus élevées, pour purifier la vaisselle.



Beer glasses

Cold final water rinse for cold and ready-to-serve glasses.

Un breve risciacquo freddo finale permette di ottenere bicchieri subito pronti all'uso.

Un bref rinçage à froid final permet de verres prêts à l'emploi.



Fragile glasses

Soft washing start function available to prevent shocks on flutes.

La funzione soft-start evita rotture ai flutes.

La fonction de démarrage progressif empêche de casser les flûtes.



Custom

You can chose your ideal washing time & temperature.

Scegli tu le temperature e i tempi di lavaggio.

C'est à vous le choix de la température et du temps de lavage.



Eco clean

Energy saving cycle.

Ciclo a risparmio energetico.

Cycle d'économie d'énergie.

ATA technology

Service QR code

Do not worry about After Sale Service!
Service QR code provides technicians with all the information needed for a correct installation, such as Manual and Installation drawings.

ATA authorized Service Partner can access the correct spare part list and quickly identify which part he needs.
He can then order it in real time from his mobile phone, without mistakes and in only 3 simple steps.

*Non preoccuparti più per il Servizio Post-Vendita!
Il Service QR code fornisce ai Centri Assistenza tutte le informazioni necessarie per una corretta installazione, come il Manuale e gli Schemi di collegamento.
Ogni Centro Assistenza autorizzato da ATA può accedere alla lista dei ricambi della lavastoviglie. Può così identificare velocemente il componente da sostituire e ordinarlo in tempo reale dal telefonino, senza errori e in solo 3 semplici passi.*

Le Service QR code offre à nos partenaires techniques toutes les informations nécessaires pour une installation correcte, tels que les manuels et les diagrammes de connexion.
Chaque centre de service autorisé par ATA peut accéder à la liste de rechange. Il peut donc identifier rapidement le composant à remplacer et le commander en temps réel à partir du téléphone mobile, sans erreurs et en seulement 3 étapes simples.

step 1

Scan Service QR code with your phone camera to automatically access to our website.

Visualizza il QR code con la fotocamera del telefonino, per essere reindirizzato automaticamente al nostro sito web.

Visualisez le code QR avec l'appareil photo du téléphone pour être automatiquement dirigé vers notre site Web.

step 2

Enter the spare part list and select the one you want to replace.

Apri la lista dei ricambi della lavastoviglie e seleziona quelli da sostituire.

Ouvrez la liste des pièces de rechange et sélectionnez celles à remplacer.

step 3

Add it to the basket and order it with the click of a button.

Aggiungi i ricambi al carrello e invia l'ordine con un semplice click.

Ajoutez les pièces de rechange au panier d'achat et envoyez la commande en un simple clic.



Video available on www.atasrl.com
Video disponibile su www.atasrl.com
Vidéo disponible sur www.atasrl.com



step 1



step 2



step 3



basic line



value line



performance line



Sturdiness and reliability

Sturdiness and reliability without compromise thanks to ATA high quality standards. Its technical solutions are easy to use and dramatically reduce its running and service cost.

Robustezza e affidabilità

Robustezza e affidabilità senza compromessi, garantite dagli standard di produzione ATA. Soluzioni tecniche studiate per massimizzare la semplicità di utilizzo e ridurre i costi di gestione e manutenzione.

Structure robuste et fiable

Structure robuste et fiable sans compromis est garantie par la production standard de ATA. Solutions techniques qui sont faciles à utiliser et économiques dans la gestion et l'entretien.

Premium performance and finishing

Designed for people looking for profitable offers and excellent quality, VALUE line stands for the right mix of technological solutions for best performance and experience during use.

Prestazioni e finiture raffinate

Pensata per clienti che ricercano un'offerta vantaggiosa abbinata alla massima qualità, Value line è un concentrato di sofisticate tecnologie mirate ad incrementare l'ergonomia di utilizzo e le prestazioni.

Rendement et finitions raffinées

Conçu pour les clients qui sont à la recherche d'une offre fructueuse combiné avec la plus haute qualité, Value Line est un mélange de technologies visant à améliorer l'utilisation et les performances.

Excellent washing

The best solution even against the toughest dirt, PERFORMANCE line represents excellence in dishwashing results thanks to the possibility to personalize washing cycles according to your needs.

L'eccellenza nel lavaggio

Performance è la linea che rappresenta l'eccellenza nelle prestazioni di lavaggio. Il meglio contro ogni tipo di sporco ostinato, grazie alla possibilità di personalizzare i cicli di lavaggio.

L'excellence dans le lavage

La série Performance représente l'excellence parmi les résultats obtenus dans le nettoyage : contre tous les types de saleté tenace, grâce à la possibilité de personnaliser les cycles de lavage.

The right glasswasher for every Barman

basic line



B 11 – 21 – 21D*



B 21

100% stainless steel

Extremely easy to use: in addition to the ON/OFF switch, the models B 11 and B 21 are characterized by just one push-button. So, they stand for the right glasswasher even for untrained users and extremely hectic bars and pubs.

100% acciaio inossidabile

Massima semplicità d'uso: con un solo tasto di comando (oltre a quello di ON/OFF) la lavabicchieri risulta semplice da utilizzare anche ad operatori inesperti.

Una soluzione perfetta per locali caratterizzati da un'alta rotazione del personale.

100% acier inoxydable

Facilité d'utilisation : avec un seul bouton (en plus de l'ON / OFF) le lave-verres est très facile à utiliser pour tous les opérateurs, aussi que pour les moins expérimentés. Une solution parfaite pour locale caractérisée par un taux de roulement élevé du personnel.



B 11

B 21

B 21D*



B 21



Stainless steel washing arms.

Their bladed nozzles keep their shape unchanged for years, when compared with plastic solutions on the market, and ensure brilliant, long-lasting results. Their stainless steel filter provides efficient water filtration and better pump protection, because it is not worn away by hot water and detergent.

Bracci di lavaggio in acciaio inox.

A differenza delle soluzioni in plastica proposte dal mercato, mantengono inalterata la forma dei getti "a lama" anche a distanza di anni, per un perfetto risultato di lavaggio. Il filtro in acciaio inox non viene eroso dall'acqua calda e dal detersivo, per un'efficacia di filtrazione costante nel tempo e una miglior protezione della pompa.

Bras de lavage en acier inox.

La forme de jets "à lame" reste inchangée même après beaucoup d'années d'utilisation, tandis que les solutions en plastiques déjà proposées dans le marché sont moins fiables. Le filtre en acier inox n'est pas détérioré par l'eau chaude et le détergent, qui garantit une constante filtration efficace et une meilleure protection de la pompe.

Classy interface with chromed buttons. Led lamps are more visible than standard to better control the machine also from far away.

Elegante interfaccia con pulsanti cromati. Le spie a led, più luminose di quelle tradizionali, permettono di controllare lo stato della macchina anche da distante.

Interface élégante avec des boutons chromés. Les voyants LED, plus lumineuses que les lampes traditionnelles, vous permettent de vérifier l'état de l'appareil, à distance aussi.



value line



AL 36 – 40 – 43



AL 36

Great comfort

Glasswashers from Value line are designed to improve your comfort. Their double-skinned door is provided with a soft-closing mechanism for easy opening and closing.

Comfort nell'utilizzo

Le lavabicchieri Value line sono progettate per ottimizzare il comfort nell'utilizzo. La porta in doppia parete è dotata di un meccanismo soft-closing che ne agevola l'apertura e la chiusura.

Confort d'utilisation

Lave-verres Value Line sont conçus pour optimiser le confort d'utilisation. La porte à double paroi est équipée d'un mécanisme de 'soft-closing' qui facilite l'ouverture et la fermeture.



AL 36

AL 40

AL 43



AL 43



Your glasswashers are ready for washing in shorter time. Thanks to their more powerful heating element in the washing tank, their heating rate is reduced by 50%, when you switch on your glasswasher for the first time*.

Pronto – macchina più rapido. Le resistenze maggiorate nella vasca riducono del 50% la velocità di riscaldamento dell'acqua alla prima accensione.*

Vitesse de mise en marche. Les résistances plus puissantes dans la cuve chauffent l'eau 50% plus rapidement* au premier allumage.



Only 1,7 lt. of water required for each washing cycle for best-in-class energy savings.

Solo 1,7Lt di consumo d'acqua per ciclo di lavaggio. Risparmio energetico ai vertici della categoria.

Consommation de 1,7 lt seulement d'eau par cycle de lavage.

*Model AL 43 as compared with the model B 21 / AL 43 rispetto al modello B 21 / AL 43 par rapport au modèle B 21.

performance line



AL 360 – 400 – 403 – 403 D*



AL 403

Best wash

Performance line stands as the more matching the needs of those barmen looking for the best washing performance.

Brilliant washing results thanks to its cycles: it is possible to optimize the washing performances according to the type of crockery.

Il miglior lavaggio

Performance line è la più indicata per i Baristi che ricercano la migliore performance di lavaggio. I cicli disponibili permettono di ottimizzare le prestazioni di lavaggio in base al tipo di stoviglie, per un risultato sempre impeccabile.

Le meilleur lavage

La série Performance Line est la plus appropriée pour les barmans qui recherchent les meilleures performances de lavage. Les cycles disponibles vous permettent d'optimiser le lavage en fonction du type de vaisselle, pour un résultat toujours impeccable.



AL 360

AL 400

AL 403
AL 403 D*

AL 403

Highly resistant and anti-scratch capacitive display, designed to bear with any modern kitchens stress.

Display capacitivo antigraffio e resistente agli urti, studiato per resistere all'utilizzo frenetico delle cucine professionali.

Affichage résistant aux rayures et aux chocs, conçu pour résister à l'utilisation frénétique des appareils professionnels.



performance line



AL 451 / 501



AL 501

Best-in-class flexibility

Thanks to their bigger basket size, models AL 451 and AL 501 are characterized by high productivity and great flexibility: barmen will appreciate the possibility of washing bigger dishes.

Massima flessibilità!

AL 451 ed AL 501, con le loro dimensioni del cesto maggiorate, mantengono le eccellenti proprietà di lavaggio bicchieri della Performance line, ma permettono ai baristi una maggiore produttività e la flessibilità di poter lavare in un'unica macchina anche i piatti di maggiori dimensioni.

Maximum de flexibilité!

AL 451 ed AL 501, grâce à panier plus grand, conservent les excellentes propriétés de lavage de la Performance Line et permettent une plus grande productivité et la flexibilité de laver dans un seul appareil aussi de assiettes plus grandes.



AL 451

AL 501



AL 501

Perfect to clean beer glasses and ice cream cups in high quantities. You can use them immediately after washing, thanks to a specific cold final rinse.

Perfette per lavare coppe gelato e boccali da birra in quantità elevate, grazie al ciclo specifico a risciacquo freddo finale che permette di servirli immediatamente dopo il lavaggio.

Parfait pour le lavage en grande quantité de tasses à crème glacée et de chopes à bière, grâce au cycle spécifique avec rinçage à froid qui permet de les servir immédiatement après le lavage.



performance line



AL 247



AL 247

Premium finishing

AL 247 is featuring the most refined design, well identified by its touch screen display and rounded and smooth internal shape.

A double-skinned, insulated washing tank increases your comfort, thanks to lower noise and remarkable energy savings.

Design di gran classe

AL 247 è la lavabicchieri dal design più ricercato, con il display touch-screen e le superfici interne arrotondate ed eleganti. La vasca in doppia parete con isolamento aumenta il confort dell'operatore riducendo la rumorosità, e migliora ulteriormente i consumi energetici.

Design premium

Le modèle AL 247 est le lave-verres avec le design le plus sophistiqué, avec un affichage tactile et des surfaces internes arrondies et élégantes. La cuve à double paroi avec isolation augmente le confort de l'opérateur en réduisant le bruit et améliore encore la consommation d'énergie.



AL 247



AL 247



Rounded edges in the washing tank prevent dirt from being stuck in corners. You will experience quicker cleaning operations and a better smelling glasswasher.

I bordi raggiati della vasca impediscono allo sporco di rimanere intrappolato negli spigoli. La pulizia sarà più veloce e si eviteranno i cattivi odori.

Les bords arrondis de la cuve empêchent la concentration de la saleté les coins. Le nettoyage sera plus rapide et les odeurs mauvaises seront évitées.



HD Full-touch display with colored icons, the most intuitive and easy to use.

Il Full-Touch display in HD ad icone colorate è intuitivo e più facile da usare.

L'affichage Full-Touch HD avec icônes colorées est intuitif et facile à utiliser.

	 mm	 mm	 mm	 Volt/Hz	kW	 Program	
 B11	a 480 b 420 h 605	350 x 350	220	230 V ~ 1 ph 50 Hz	3,25	1	30
 B21	a 530 b 470 h 700	400 x 400	290	230 V ~ 1 ph 50 Hz	3,25	1	30
 B21D	a 530 b 470 h 700	400 x 400	290	230 V ~ 1 ph 50 Hz	3,25	1	30
 AL36	a 480 b 420 h 605	350 x 350	215	230 V ~ 1 ph 50 Hz	2,8	1	30
 AL40	a 530 b 470 h 665	400 x 400	290	230 V ~ 1 ph 50 Hz	2,8	1	30
 AL43	a 530 b 470 h 700	400 x 400	290	230 V ~ 1 ph 50 Hz	2,8	1	30

	 mm	 mm	 mm	 Volt/Hz	kW	 Program	
 AL360	a 480 b 420 h 605	350 x 350	215	230 V ~ 1 ph 50 Hz	2,8	7	60 max 10 min
 AL400	a 530 b 470 h 665	400 x 400	290	230 V ~ 1 ph 50 Hz	2,8	7	60 max 10 min
 AL403	a 530 b 470 h 700	400 x 400	290	230 V ~ 1 ph 50 Hz	2,8	8	60 max 10 min
 AL403 D	a 530 b 470 h 700	400 x 400	290	230 V ~ 1 ph 50 Hz	2,8	8	60 max 10 min
 AL247	a 530 b 485 h 715	400 x 400	265	230 V ~ 1 ph 50 Hz	2,8	8	60 max 10 min
 AL451	a 550 b 520 h 780	450 x 450	270	230 V ~ 1 230 V ~ 3 400 V ~ 3N 50 Hz	3,5	8	60 max 10 min
 AL501	a 600 b 600 h 820	500 x 500	290	230 V ~ 1 230 V ~ 3 400 V ~ 3N 50 Hz	3,5	8	60 max 10 min



professional dishwashers

ATA srl

Viale del Progresso, 20 - ZI
35026 Conselve (Padova) - Italy
Tel. +39 049 9500555
Fax. +39 049 9500560
mail@atasrl.com
www.atasrl.com





Lavavasos

Посудомоечная машина для стаканов /
Gläser-spülmaschinen





Hazlo posible con ATA connect

Imagina que el técnico mismo entre en tu restaurante y te pida de poder revisar el lavavajillas, en lugar de tener que llamarlo. Imagina que el técnico conozca el problema de tu lavavajillas incluso antes de verlo y que pueda repararlo rápidamente, ya teniendo el repuesto correcto. Ahora es posible con nuestros lavavastos WiFi.

Сделайте это возможным при помощи ATA connect.

Представьте себе, что техник-специалист входит в ваш ресторан и просит разрешения проверить вашу посудомоечную машину, и вам даже не пришлось его вызывать. Представьте себе, что техник-специалист знает, что именно неисправно в вашей посудомоечной машине, ещё до того, как увидит саму машину, он сможет быстро её наладить, и у него всегда найдётся подходящая запчасть. Теперь это стало возможным с нашими WiFi посудомоечными машинами для стаканов.

Machen Sie es möglich mit ATA Connect.

Stellen Sie sich vor, der Techniker betritt Ihr Restaurant und bittet Sie, den Geschirrspüler zu überprüfen, anstatt dass Sie ihn anrufen müssen. Stellen Sie sich vor, der Techniker kennt das Problem Ihres Geschirrspülers, schon bevor er sie sich angesehen hat, und er kann sie schnell reparieren, wobei er immer das richtige Ersatzteil dabei hat. Das ist jetzt mit unseren WLAN-Geschirrspülmaschinen.

Las nuevas funcionalidades a tu servicio /
Новая функциональность - к вашим услугам /
Neue Funktionen zu Ihren Diensten



Control remoto

Siempre conectado a tu centro de asistencia, para que te sientas cómodo.

Удалённая проверка

Постоянно на связи с вашим Центром технической помощи, ради вашего спокойствия.

Steuerung über Fernbedienung

Immer mit Ihrem Kundendienstzentrum verbunden, damit Sie sich um nichts sorgen müssen



Mantenimiento preventivo

Informes de mantenimiento periódico, para evitar paradas de la máquina.

Профилактическое техобслуживание

Сообщения о периодическом техобслуживании, чтобы избежать простоев оборудования.

Vorbeugende Wartung

Berichterstattung über regelmäßige Wartungen, um Maschinenstillstände zu vermeiden.



Envío de mensajes de error

Comunicación de problemas vía WiFi, para un mantenimiento más rápido.

Отправка сообщений об ошибке

Передача информации о неисправности через WiFi, для более быстрого ремонта

Senden von Fehlermeldungen

Kommunikation von Problemen über WLAN für eine schnellere Wartung.



Programación de ciclos remotos

Cambio de parámetros de lavado más rápido y más barato.

Удалённое программирование циклов мойки

Изменение параметров для более быстрой и экономичной мойки.

Remote-Zyklusprogrammierung

Schnellere und wirtschaftlichere Änderungen der Spülparameter.

ATA connect

Disfrutes del mejor servicio de asistencia técnica del mercado con ATA Connect, el sistema que combina la tecnología de transmisión de datos WiFi con un código QR de asistencia. Tu técnico puede monitorear el lavavajillas a distancia y la máquina le envía señales de error, a veces incluso antes de que hayas notado el problema.

También aconseja al técnico cuándo realizar el mantenimiento preventivo, para que pueda programarse cuando el local no esté abierto al público y evitar tiempos de inactividad durante el servicio.

¿No está satisfecho con los 8 ciclos de lavado preestablecidos? ¿El lavavajillas ya no lava bien después de cambiar la marca de detergente? No te preocupes: tu técnico podrá cambiar los parámetros del ciclo de forma remota y rápida.

Finalmente, puedes concentrarte en lo que más amas hacer: cuidar de tus clientes.

Наслаждайтесь наилучшей на рынке Службой технической помощи ATA Connect, которая сочетает WiFi технологию передачи данных со службой QR-кода. Посудомоечная машина удалённо отслеживается вашим техником-специалистом, машина сама отправляет технику сообщения при возникновении ошибок, иногда даже раньше, чем вы заметили проблему.

Кроме того, машина подсказывает технику, когда требуется провести профилактическое техобслуживание, чтобы спланировать его на то время, когда заведение закрыто для публики и избежать простоев машины во время работы.

Вы не удовлетворены 8-ю предустановленными моечными циклами? Посудомоечная машина перестала хорошо мыть после смены марки моющего средства? Не беспокойтесь: ваш техник в кратчайшее время сможет удалённо изменить параметры цикла.

Наконец-то вы сможете сосредоточиться на том, чем вам больше нравится заниматься: обслуживанием ваших клиентов.

Mit ATA Connect, dem System, das die WLAN-Datenübertragungstechnologie mit einem Service-QR-Code kombiniert, können Sie den besten technischen Support auf dem Markt genießen. Der Geschirrspüler wird von Ihrem Techniker fernüberwacht und sendet die Fehlermeldungen manchmal sogar noch bevor Sie das Problem bemerkt haben.

Sie weist den Techniker auch darauf hin, wenn vorbeugende Wartungsarbeiten anstehen, damit diese programmiert werden können, wenn das Lokal nicht für die Öffentlichkeit zugänglich ist, und um Ausfallzeiten der Maschine während der Wartung zu vermeiden.

Genügen Ihnen die 8 voreingestellten Spülzyklen nicht? Spült der Geschirrspüler nach einem Wechsel der Spülmittelmarke nicht mehr richtig? Keine Sorge: Ihr Techniker kann die Zyklusparameter aus der Ferne schnell ändern.

Endlich können Sie sich auf das konzentrieren, was Sie am liebsten tun: sich um Ihre Gäste kümmern.



Video disponible en www.atasrl.com
Видео доступно на сайте: www.atasrl.com
Video auf www.atasrl.com verfügbar

ATA advantages



Auto-clean

Un ciclo de autolimpieza reduce el tiempo y el costo de la limpieza del lavavajillas..

Цикл самоочистки позволяет сократить время и стоимость чистки посудомоечной машины.

Ein Selbstreinigungszyklus reduziert die Zeit und die Kosten für die Reinigung des Geschirrspülers.



Water softener

Nuestro ablandador de agua de última generación (modelos con D) regenera las resinas durante el ciclo de lavado, sin tiempo de inactividad de la máquina.

Наш умягчитель воды (модели с литерой D) последнего поколения восстанавливает смолы во время цикла мойки, без простоев машины.

Unser Wasserenthärter der neuesten Generation (Modelle mit D) regeneriert die Harze während des Waschzyklus ohne Maschinenausfallzeiten.



Thermolock System

Asegura la perfecta higienización de los vasos, gracias a que el ciclo de enjuague solo se hace con agua a 82°C.

Thermolock - это система, обеспечивающая санитарную обработку посуды, поскольку позволяет ополаскивать её лишь водой температурой не ниже 82°C.

Thermolock ist das System, das die Desinfektion von Geschirr garantiert, da es das Nachspülen nur mit 82° C heißem Wasser zulässt.



Smart Dispenser

Sistema de dosificación inteligente del detergente (opcional), detecta la cantidad de suciedad y dispensa la dosis justa de detergente.

Система "умного" дозирования моющего средства (опция), которая "чувствует" грязь и выдаёт строго необходимое количество моющего средства.

Intelligentes Dosiersystem für das Geschirrspülmittel (optional), das den Schmutz „fühlt“ und nur die benötigte Menge ausgibt.



Cups

Ciclo corto y de bajo consumo energético, específico para las manchas de café y leche.

Короткий цикл с низким энергопотреблением, специально для пятен кофе и молока.

Kurzer Zyklus mit geringem Energieverbrauch, speziell für Kaffee- und Milchflecken.



Glasses

Vasos secos y brillantes con un ciclo de lavado corto combinado con un enjuague suave.

Сухие и блестящие стаканы с коротким циклом мойки, в сочетании с нежным ополаскиванием.

Trockene und glänzende Gläser mit einem kurzen Waschgang, kombiniert mit sanftem Abspülen.



Cutlery

Los cubiertos se pueden lavar a altas temperaturas para eliminar mejor la suciedad sin deteriorarlos.

Столовые приборы можно мыть при высокой температуре, чтобы лучше удалить загрязнения, без повреждения приборов.

Besteck kann bei hohen Temperaturen gewaschen werden, um Schmutz gründlich zu entfernen, ohne es zu beschädigen.



Sanitization

Un mayor tiempo de lavado, a temperaturas más altas, para desinfectar la vajilla.

Большее время мойки, при более высокой температуре, для санитарной обработки посуды.

Eine längere Waschzeit bei höheren Temperaturen, um das Geschirr zu desinfizieren.



Beer glasses

Un breve enjuague final en frío, permite obtener vasos inmediatamente listos para usar.

Короткое финальное ополаскивание холодной водой позволяет получить стаканы, немедленно готовые к применению.

Ein kurzes abschließendes kaltes Spülen ermöglicht es Ihnen, die Gläser sofort einsatzbereit zu machen.



Fragile glasses

La función soft-start evita roturas a los flutes.

Функция мягкого старта позволяет избежать раскола фужеров.

Die Softstart-Funktion vermeidet Brüche von empfindlichen Sektgläsern.



Custom

Eliges tu las temperaturas y tiempos de lavado.

Вы сами выбираете температуру и время мойки.

Wählen Sie selbst die Temperaturen und Waschzeiten.



Eco clean

Ciclo de ahorro de energía.

Цикл с экономией энергии.

Energiesparzyklus.

ATA technology

Service QR code

El código QR de Asistencia proporciona a nuestros socios técnicos toda la información necesaria para una instalación correcta, como el Manual y los diagramas de conexión. Cada centro de asistencia autorizado por ATA puede acceder a la lista de repuestos del lavavajillas. De este modo, puede identificar rápidamente el componente a reemplazar y solicitarlo en tiempo real desde el teléfono, sin errores y en solo 3 simples pasos.

Служба QR-кода даёт нашим партнёрам – техникам всю информацию, необходимую для правильной установки оборудования, т.е. Руководства и Схемы подключения. Каждый Авторизованный сервисный центр фирмы ATA может получить доступ к списку запчастей посудомоечной машины. Таким образом, Сервисный центр может быстро определить часть, требующую замены, и заказать её в реальном времени с сотового телефона, безошибочно и всего лишь за 3 простых шага.

Mit dem Service-QR-Code erhalten unsere technischen Partner alle Informationen, die für eine ordnungsgemäße Installation erforderlich sind, z. B. das Handbuch und die Anschlusspläne. Jedes zugelassene ATA-Service-Center kann auf die Ersatzteilliste für Geschirrspüler zugreifen. So kann es die auszutauschende Komponente schnell identifizieren und in Echtzeit fehlerfrei und in nur 3 einfachen Schritten über das Telefon bestellen.

step 1

Veas el código QR con la cámara del teléfono, para ser redirigido automáticamente a nuestro sitio web.

Навести на QR-код камеру сотового телефона, автоматически произойдёт перенаправление на наш интернет-сайт.

Erfassen Sie den QR-Code mit der Kamera des Telefons, um automatisch auf unsere Website umgeleitet zu werden.

step 2

Abras la lista de piezas del lavavajillas y seleccione las que desea reemplazar.

Открыть список запчастей посудомоечной машины и выбрать части, требующие замены.

Öffnen Sie die Liste der Ersatzteile für Geschirrspüler und wählen Sie die Teile aus, die ausgetauscht werden sollen.

step 3

Agregue los repuesto al carrito de compras y envíe el pedido con un simple clic.

Добавить запчасти в корзину и отправить заказ одним кликом.

Legen Sie die Ersatzteile in den Warenkorb und senden Sie die Bestellung mit einem einfachen Klick ab.



Video disponible en www.atasrl.com
Видео доступно на сайте: www.atasrl.com
Video auf www.atasrl.com verfügbar



step 1



step 2



step 3



basic line



value line



performance line



Robustez y fiabilidad

Resistencia y fiabilidad sin compromiso, garantizadas por los estándares de producción ATA. Soluciones técnicas diseñadas para maximizar la facilidad de uso y reducir los costos de gestión y mantenimiento.

Прочность и надёжность

Бескомпромиссная прочность и надёжность, гарантированные стандартом производства компании ATA. Технические решения, разработанные для максимального упрощения использования и снижения стоимости управления и обслуживания.

Robust und zuverlässig

Robust und zuverlässig ohne Kompromisse, garantiert durch ATA-Produktionsstandards. Technische Lösungen zur Maximierung der Benutzerfreundlichkeit und Reduzierung der Kosten für Verwaltung und Wartung.

Rendimiento y acabados refinados

Diseñada para clientes que buscan una oferta ventajosa combinada con la más alta calidad, la línea Value es un concentrado de tecnologías sofisticadas destinadas a aumentar la ergonomía de uso y el rendimiento.

Изысканное исполнение и отделка

Данная линия создана для тех клиентов, которые ищут выгодные предложения в сочетании с максимальным качеством, Value line - это средоточие сложных технологий, нацеленных на улучшение эргономики и рабочих характеристик.

Hochwertige Leistungen und Oberflächen raffiniées

Die Value-Linie wurde für Kunden entwickelt, die ein vorteilhaftes Angebot in Verbindung mit maximaler Qualität suchen. Sie ist ein Konzentrat aus hoch entwickelten Technologien, die auf eine Steigerung der Ergonomie bei der Verwendung und in der Leistung abzielen.

Excelencia en lavado

Performance es la línea que representa la excelencia en el rendimiento de lavado. Lo mejor contra todo tipo de suciedad persistente, gracias a la posibilidad de personalizar los ciclos de lavado.

Превосходная мойка

Performance - это линия, обеспечивающая превосходную степень качества мойки. Самая лучшая очистка любых трудноудаляемых загрязнений благодаря возможности персонализировать циклы мойки.

Exzellente Spülqualität

Performance ist die Linie, die für hervorragende Spüleleistung steht. Das Beste gegen alle Arten von hartnäckigem Schmutz, dank der Möglichkeit, die Spülzyklen individuell anzupassen.

El lavavastos ideal para todos los barman.

Идеальная посудомоечная машина для стаканов для каждого бармена

Die ideale Gläserspülmaschine für jeden Barman

basic line



B 11 – 21 – 21D*



B 21

100% acero inox

Máxima simplicidad de uso: con un solo botón de control (además del botón de ENCENDIDO / APAGADO), el lavavasos es fácil de usar incluso para operadores sin experiencia. Una solución perfecta para locales con alta rotación de personal.

100% нержавеющей сталь

Максимальная простота использования: управление при помощи одной кнопки (помимо кнопки ВКЛ/ВЫКЛ) - посудомоечной машиной просто пользоваться даже неопытным операторам. Идеальное решение для заведений с высокой ротацией персонала.

100 % rostfreier Edelstahl

Höchster Bedienkomfort: Mit nur einer Bedientaste (zusätzlich zur EIN-AUS-Taste) ist die Gläserspülmaschine auch für unerfahrene Personen einfach zu bedienen. Eine perfekte Lösung für Lokale mit hoher Mitarbeiter-Rotation.



B 11

B 21

B 21D*



B 21



Brazos de lavado en acero inoxidable. A diferencia de las soluciones plásticas que ofrece el mercado, mantienen sin alteraciones la forma de "cuchillo" de los chorros, incluso años más tarde, para un resultado de lavado perfecto. El filtro de acero inoxidable no es erosionado por el agua caliente y el detergente, para una eficiencia de filtrado constante y una mejor protección de la bomba.

Моечные рукава из нержавеющей стали. В отличие от пластмассовых решений, представленных на рынке, они сохраняют неизменной форму "ножевых" струй даже спустя много лет, для достижения идеального результата мойки. Фильтр из нержавеющей стали не корродирует от горячей воды и моющего средства, обеспечивая эффективную фильтрацию, неизменную с течением времени, и лучшую защиту насоса.

Sprüharme aus rostfreiem Edelstahl. Im Gegensatz zu den auf dem Markt angebotenen Kunststoff-Sprühdüsen bleiben die „klingenförmigen“ Düsen über lange Jahre unverändert und es wird immer ein perfektes Spülergebnis erzielt. Der Edelstahlfilter wird durch heißes Wasser und Reinigungsmittel nicht angegriffen und somit ist eine konstante Filtrationseffizienz und ein besserer Schutz der Pumpe gewährleistet.

Interfaz elegante con botones cromados. Las luces LED, más brillantes que las tradicionales, permiten verificar el estado de la máquina incluso a distancia.

Еlegantный интерфейс с хромированными кнопками. Светодиодные контрольные лампы, более яркие, чем традиционные, позволяют контролировать состояние машины даже на расстоянии.

Elegante Benutzeroberfläche mit Chromknöpfen. Mit LED-Leuchten, die heller als herkömmliche Leuchten sind, können Sie den Status des Geräts auch aus der Ferne überprüfen.



value line



AL 36 – 40 – 43



AL 36

Comodidad de uso

Los lavavasos de la línea Value están diseñados para optimizar la comodidad de uso. La puerta de doble pared está equipada con un mecanismo de cierre suave que facilita la apertura y el cierre.

Комфорт для пользователя

Посудомоечные машины для стаканов Value line спроектированы так, чтобы пользователю было максимально комфортно. Дверца с двойной стенкой имеет механизм мягкого закрывания, облегчающий её открытие и закрытие.

Komfort im Gebrauch

Gläserespülmaschinen Value Line sind darauf ausgelegt, den Bedienkomfort zu optimieren. Die doppelwandige Tür ist mit einem Dämpfungsmechanismus ausgestattet, der das Öffnen und Schließen erleichtert.



AL 36

AL 40

AL 43



AL 43



Máquina lista más rápidamente. Las resistencias aumentadas en el tanque reducen del 50% la velocidad de calentamiento del agua en el primer encendido*.

Pronto – более быстрая машина. Более мощные ТЭНы ванны увеличивают на 50% скорость нагрева воды при первом включении*.

Schnellere Betriebsbereitschaft des Geräts. Die verstärkten Heizwiderstände im Tank reduzieren die Wasseraufheizgeschwindigkeit beim ersten Einschalten* um 50%.



Solo 1,7 Lt de consumo de agua por ciclo de lavado. Ahorro de energía a la cima de su categoría.

Всего лишь 1,7 л расхода воды на цикл мойки. Максимальная экономия энергии для данной категории.

Nur 1,7 Liter Wasserverbrauch pro Spülgang. Energieeinsparung an der Spitze der Kategorie.

*En AL43 comparado con el modelo B21 / AL43 относительно модели B21 / AL43 im Vergleich zum Modell B21

performance line



AL 360 – 400 – 403 – 403 D*



AL 403

El mejor lavado

La línea Performance es la más adecuada para los baristas que buscan el mejor rendimiento de lavado. Los 8 ciclos disponibles permiten optimizar el rendimiento de lavado según el tipo de vajilla, para un resultado siempre impecable.

Наилучшая мойка

Серия посудомоечных машин Performance line наиболее показана для барменов, которые стремятся к наилучшему качеству мойки. 8 предустановленных циклов позволяют оптимизировать параметры мойки в зависимости от типа посуды, для достижения всегда безупречного результата.

Beste Spülleistung

Die Performance Line ist für Barbetreiber geeignet, für die beste Waschleistung das Wichtigste ist. Mit den 8 verfügbaren Zyklen können Sie die Spülleistung je nach Geschirrtyp optimieren, um stets ein einwandfreies Ergebnis zu erzielen.



AL 360

AL 400

AL 403
AL 403 D*

AL 403

Pantalla capacitiva resistente a los arañazos y a los impactos, diseñada para resistir el uso frenético de las cocinas profesionales.

Ёмкостный царапиноустойчивый и ударопрочный дисплей разработан специально для использования в "лихорадочной" атмосфере профессиональной кухни.

Kratzfeste und schlagfeste Kapazitätsanzeige, die dem hektischen Einsatz gewerblicher Küchen standhält.



performance line



AL 451 / 501



AL 501

Máxima flexibilidad

AL 451 y AL 501, con sus dimensiones de cesta incrementadas, mantienen las excelentes propiedades de lavado de la línea Performance, pero permiten a los baristas una mayor productividad y la flexibilidad de poder lavar también los platos más grandes en una sola máquina.

Максимальная гибкость

Модели AL 451 и AL 501, с увеличенными размерами корзины, сохраняют великолепные свойства мойки стаканов линии Performance, но позволяют барменам добиться большей производительности и гибкости, имея возможность мыть в одной машине также тарелки больших размеров.

Beste Anpassungsfähigkeit

AL 451 und AL 501 mit ihren vergrößerten Korbabmessungen behalten die hervorragenden Spüleigenschaften der Performance Line bei, ermöglichen jedoch eine höhere Produktivität und die Flexibilität, auch größere Geschirrtteile in einem einzigen Gerät zu spülen.



AL 451

AL 501



AL 501

Perfecto para lavar copas de helado y jarras de cerveza en grandes cantidades, gracias al ciclo específico con enjuague final en frío, que permite servirlos inmediatamente después del lavado.

Идеальны для мойки большого количества вазочек для мороженого и пивных бокалов, благодаря специальному циклу холодного финального ополаскивания, позволяющему подавать посуду клиентам немедленно после мойки.

Perfekt zum Spülen von Eisbechern und Bierkrügen in großen Mengen, dank des speziellen Zyklus mit abschließender Kaltspülung, damit Sie sie sofort nach dem Spülen wieder verwenden können.



performance line



AL 247



AL 247

Diseño elegante

AL 247 es el lavavasos con diseño más sofisticado, con pantalla táctil y superficies internas redondeadas y elegantes. La cuba de doble pared con aislamiento aumenta la comodidad del operador, al reducir el ruido, y mejora aún más los consumos de energía.

Высококласный дизайн

AL 247 - это посудомоечные машины для бокалов самого изысканного дизайна, с сенсорным дисплеем и элегантными закруглёнными внутренними поверхностями. Ванна с двойной стенкой с теплошумоизоляцией увеличивает комфорт оператора, снижая шум, и даёт ещё большую экономию энергии.

Ganz besonders edles Design

Der AL 247 ist der hochwertigste Design-Gläserspüler mit Touchscreen-Display und abgerundeten und eleganten Innenflächen. Der doppelwandige Tank mit Isolierung erhöht den Bedienkomfort durch Geräuschreduzierung und verbessert den Energieverbrauch weiter.



AL 247



AL 247



Los bordes redondeados de la cuba evitan que la suciedad quede atrapada en las esquinas. La limpieza será más rápida y se evitarán los olores.

Закруглённые края ванны не позволяют грязи скапливаться в углах. Чистка будет быстрее, отсутствие плохого запаха.

Die abgerundeten Kanten des Tanks verhindern, dass sich Schmutz in den Ecken ablagert. Die Reinigung erfolgt schneller und Gerüche werden vermieden.



La pantalla Full-Touch HD con iconos de colores es intuitiva y más fácil de usar.

Полностью сенсорный HD дисплей с цветными пиктограммами - интуитивный и более простой в использовании.

Das Full-Touch HD-Display mit farbigen Symbolen ist intuitiv und einfacher zu bedienen.

	 mm	 mm	 mm	 Volt/Hz	kW	 Program	
 B11	a 480 b 420 h 605	350 x 350	220	230 V ~ 1 ph 50 Hz	3,25	1	30
 B21	a 530 b 470 h 700	400 x 400	290	230 V ~ 1 ph 50 Hz	3,25	1	30
 B21D	a 530 b 470 h 700	400 x 400	290	230 V ~ 1 ph 50 Hz	3,25	1	30
 AL36	a 480 b 420 h 605	350 x 350	215	230 V ~ 1 ph 50 Hz	2,8	1	30
 AL40	a 530 b 470 h 665	400 x 400	290	230 V ~ 1 ph 50 Hz	2,8	1	30
 AL43	a 530 b 470 h 700	400 x 400	290	230 V ~ 1 ph 50 Hz	2,8	1	30

	 mm	 mm	 mm	 Volt/Hz	kW	 Program	
 AL360	a 480 b 420 h 605	350 x 350	215	230 V ~ 1 ph 50 Hz	2,8	7	60 max 10 min
 AL400	a 530 b 470 h 665	400 x 400	290	230 V ~ 1 ph 50 Hz	2,8	7	60 max 10 min
 AL403	a 530 b 470 h 700	400 x 400	290	230 V ~ 1 ph 50 Hz	2,8	8	60 max 10 min
 AL403 D	a 530 b 470 h 700	400 x 400	290	230 V ~ 1 ph 50 Hz	2,8	8	60 max 10 min
 AL247	a 530 b 485 h 715	400 x 400	265	230 V ~ 1 ph 50 Hz	2,8	8	60 max 10 min
 AL451	a 550 b 520 h 780	450 x 450	270	230 V ~ 1 230 V ~ 3 400 V ~ 3N 50 Hz	3,5	8	60 max 10 min
 AL501	a 600 b 600 h 820	500 x 500	290	230 V ~ 1 230 V ~ 3 400 V ~ 3N 50 Hz	3,5	8	60 max 10 min



professional dishwashers

ATA srl

Viale del Progresso, 20 - ZI
35026 Conselve (Padova) - Italy
Tel. +39 049 9500555
Fax. +39 049 9500560
mail@atasrl.com
www.atasrl.com





Hood type dishwashers

Lavastoviglie a cappotta /
Lave-vaisselles à capot





Make it real with ATA connect

Imagine a Service Partner entering your restaurant and asking you to check your dishwasher, instead of you asking for a visit. Imagine a Service Partner that can fix your dishwasher problem quickly, instead of leaving with it standing idle and waiting to be fixed in your busy restaurant. This is now possible with WiFi connected dishwashers.



Rendilo possibile con ATA connect.

Immagina che sia il Tecnico ad entrare nel tuo ristorante e chiederti di controllare la lavastoviglie, invece di essere tu a doverlo chiamare. Immagina che il Tecnico conosca il problema della tua lavastoviglie ancora prima di vederla, e che la possa riparare velocemente, avendo sempre già con se il ricambio corretto. Ora è possibile con le nostre lavastoviglie WiFi.

Maintenant il est possible avec ATA Connect.

Imaginez que votre technicien entre dans votre restaurant et il vous demande de vérifier le lave-vaisselle. Imaginez que le technicien connaisse quel est le souci de votre lave-vaisselle avant même de le voir et qu'il puisse le réparer rapidement, si il a la pièce disponible. C'est maintenant possible avec nos lave-vaisselles WiFi.

A world of new possibilities to support you /
Le nuove funzionalità al tuo servizio /
Les nouvelles fonctionnalités à votre service



Remote monitoring

Always connected to your Service Partner for your peace of mind.

Controllo da remoto

Sempre connessa al tuo Centro Assistenza, così puoi stare tranquillo.

Télécommande

Toujours connecté à votre centre d'aide pour que vous puissiez vous sentir à l'aise.



Preventive maintenance

Periodic check alert to prevent dishwasher downtime.

Manutenzione preventiva

Segnalazione delle manutenzioni periodiche, per evitare fermi macchina.

Maintenance préventive

Rapport de maintenance périodique, pour éviter les temps d'arrêt de la machine.



Alarm warning

Remote alert notice for faster problem solving.

Invio dei messaggi di errore

Comunicazione dei problemi via WiFi, per una manutenzione più rapida.

Envoi de messages d'erreur

Communication des problèmes via WiFi, pour une maintenance plus rapide.



Remote setting

Faster cycle parameter change. No Service charge.

Programmazione dei cicli da remoto

Modifica dei parametri di lavaggio più veloce ed economica.

Programmation à distance des cycles

Changement plus rapide des paramètres de lavage.



ATA connect

Enjoy the best Service Experience in the market with ATA Connect, our technology combining WiFi data transmission system to a Service QR code. Your dishwasher is 24/7 connected to your Service Partner, who can control it by remote. He can also receive Alarm alerts in real time, sometimes even before you might be aware of any problem.

The dishwasher can also recommend your Service Partner a preventive service check, when needed. So you can plan it during low workload timing, and reduce the risk of failures when the location is busy.

Not satisfied about the 8 pre-set programs? The dishwasher is not washing well after changing your chemical brand? Not a problem: your Service Manager can change your cycle settings from remote, quickly and without charging the cost of a visit.

You can finally focus on what you care the most: your customers.

Goditi il miglior Servizio di Assistenza Tecnica sul mercato con ATA Connect, il sistema che combina la tecnologia WiFi di trasmissione dati ad un Service QR code. La lavastoviglie è costantemente monitorata da remoto dal tuo tecnico, e gli invia eventuali segnali di errore, a volte persino prima che tu ti sia accorto del problema.

La lavastoviglie consiglia inoltre al tecnico quando fare la manutenzione preventiva, così da poterla programmare quando il locale non è aperto al pubblico ed evitare fermi macchina durante il servizio.

Non sei soddisfatto degli 8 cicli di lavaggio pre-impostati? La lavastoviglie non lava più bene dopo aver cambiato la marca di detersivo? Non ti preoccupare: il tuo tecnico potrà cambiare i parametri di ciclo da remoto, velocemente e senza farti pagare l'uscita.

Finalmente puoi concentrarti su quello che ami fare di più: prenderti cura dei tuoi clienti.

Profitez de la meilleure technologie d'assistance technique disponible sur le marché avec ATA Connect, le système combine la transmission de données WiFi à un service de code QR. Le lave-vaisselle est surveillé à distance de votre service technique et envoie des signaux d'erreur, parfois avant que vous même aviez remarqué le souci.

Il indique également au technicien à quel moment effectuer la maintenance préventive, afin de pouvoir la programmer lorsque votre activité n'est pas ouverte au public et d'éviter d'arrêter l'appareil pendant le service.

Pas satisfait des 8 cycles de lavage pré-réglés? Le lave-vaisselle ne lave pas aussi bien après avoir changé la marque de détergent? Ne vous inquiétez pas: votre technicien peut modifier les paramètres du cycle à distance.

Enfin, vous pouvez vous concentrer sur ce que vous aimez le plus: prendre soin de vos clients.



Video available on www.atasrl.com
Video disponibile su www.atasrl.com
Vidéo disponible sur www.atasrl.com

ATA advantages

Auto-clean

Auto-clean cycle reduce the hassle & cost of manual washing.

Un ciclo di auto-pulizia permette di ridurre il tempo e il costo di pulizia della lavastoviglie.

Un cycle d'autonettoyage réduit le temps et les coûts de nettoyage.

PRP - Perfect Rinse Performance

Rinsing cycle guaranteed at 82°C and constant pressure, for sanitized crockeries and reduced drying time.

Risciacquo ad 82°C e a pressione costante, per sanitzare le stoviglie e ridurre i tempi di asciugatura.

Rinçage à 82°C et pression constante pour de parfaites performances de rinçage avec des temps de séchage réduits et une hygiénisation de la vaisselle.

Thermolock System

Thermolock system ensures dishes sanitization because the rinsing cycle only starts when water is at 82°C.

Thermolock è il sistema che garantisce la sanitizzazione dei bicchieri, perché non permette di risciacquare se non con acqua ad 82°C.

Le système 'Thermolock' garantit la parfaite hygiène de la vaisselle car le cycle de rinçage commence seulement quand l'eau est à 82°C.

Smart Dispenser

Smart dosing system – available on demand – that "feels" dirt level and pours in only the needed detergent when it is needed.

Sistema di dosaggio intelligente del detersivo (optional), che 'sente' lo sporco e ne immette solo la quantità necessaria.

Système de dosage intelligent de détergent qui capte le degré de la saleté et ne diffuse que la quantité requise.



Plates

Most flexible cycle for different kind of stains like grease, oil or starches.

Il ciclo più versatile per differenti tipi di sporco come grassi, proteine o amidi.

Le cycle le plus polyvalent pour différents types de saleté tels que les graisses, les protéines ou les amidons.

Glasses

Short washing cycle combined to a gentle rinsing, for perfectly dry and shining result.

Bicchieri asciutti e brillanti con un ciclo di lavaggio corto abbinato a un risciacquo delicato.

Verres séchés et brillants avec un cycle de lavage court combiné à un rinçage doux.

Cutlery

Washed & rinsed at high temperature, cutlery can shine without being deteriorated.

Le posate possono essere lavate ad alte temperature per rimuovere meglio lo sporco, senza deteriorarle.

Les couverts peuvent être lavés à haute température pour mieux enlever la saleté, sans les endommager.

Sanitization

Higher temperature and longer washing time can sanitize your crockeries.

Un maggior tempo di lavaggio, a temperature più alte, per sanitzare le stoviglie.

Un temps de lavage plus long et des températures plus élevées.

Pots

Longer cycle for heavily soiled crockeries.

Un ciclo più lungo per oggetti molto sporchi e incrostati.

Un cycle plus long pour les ustensiles très sales et incrustés.

Fragile glasses

Soft washing start function available to prevent shocks on flutes.

La funzione soft-start evita rotture ai flutes.

La fonction de démarrage progressif empêche de casser les flûtes.

Custom

You can chose your ideal washing time & temperature.

Scegli tu le temperature e i tempi di lavaggio.

C'est à vous le choix de la température et du temps de lavage.

Eco clean

Energy saving cycle.

Ciclo a risparmio energetico.

Cycle d'économie d'énergie.

ATA technology

Service QR code

Do not worry about After Sale Service!
Service QR code provides technicians with all the information needed for a correct installation, such as Manual and Installation drawings.

ATA authorized Service Partner can access the correct spare part list and quickly identify which part he needs. He can then order it in real time from his mobile phone, without mistakes and in only 3 simple steps.

*Non preoccuparti più per il Servizio Post-Vendita!
Il Service QR code fornisce ai Centri Assistenza tutte le informazioni necessarie per una corretta installazione, come il Manuale e gli Schemi di collegamento.
Ogni Centro Assistenza autorizzato da ATA può accedere alla lista dei ricambi della lavastoviglie. Può così identificare velocemente il componente da sostituire e ordinarlo in tempo reale dal telefonino, senza errori e in solo 3 semplici passi.*

Le Service QR code offre à nos partenaires techniques toutes les informations nécessaires pour une installation correcte, tels que les manuels et les diagrammes de connexion. Chaque centre de service autorisé par ATA peut accéder à la liste de rechange. Il peut donc identifier rapidement le composant à remplacer et le commander en temps réel à partir du téléphone mobile, sans erreurs et en seulement 3 étapes simples.

step 1

Scan Service QR code with your phone camera to automatically access to our website.

Visualizza il QR code con la fotocamera del telefonino, per essere reindirizzato automaticamente al nostro sito web.

Visualisez le code QR avec l'appareil photo du téléphone pour être automatiquement dirigé vers notre site Web.

step 2

Enter the spare part list and select the one you want to replace.

Apri la lista dei ricambi della lavastoviglie e seleziona quelli da sostituire.

Ouvrez la liste des pièces de rechange et sélectionnez celles à remplacer.

step 3

Add it to the basket and order it with the click of a button.

Aggiungi i ricambi al carrello e invia l'ordine con un semplice click.

Ajoutez les pièces de rechange au panier d'achat et envoyez la commande en un simple clic.



Video available on www.atasrl.com
Video disponibile su www.atasrl.com
Vidéo disponible sur www.atasrl.com



step 1



step 2



step 3



basic line



Sturdiness and reliability

Sturdiness and reliability without compromise thanks to ATA high quality standards. Easy to use technical solutions, focused on running and service cost reduction.

Robustezza e affidabilità

Robustezza e affidabilità senza compromessi, garantite dagli standard di produzione ATA. Soluzioni tecniche studiate per massimizzare la semplicità di utilizzo e ridurre i costi di gestione e manutenzione.

Structure robuste et fiable

Structure robuste et fiable sans compromis est garantie par la production standard de ATA. Solutions techniques qui sont faciles à utiliser et économiques dans la gestion et l'entretien.

value line



Premium performance and finishing

Designed for people looking for profitable offers and excellent quality, Value line stands for the right mix of technological solutions for reducing energy consumption, improving water filtration efficiency and speeding up cleaning operations.

Prestazioni e finiture raffinate

Pensata per chi ricerca un'offerta vantaggiosa abbinata alla massima qualità, Value line è un concentrato di tecnologie mirate a ridurre il consumo energetico, a migliorare l'efficienza del sistema di filtrazione e a velocizzare le operazioni di pulizia.

Rendement et finitions raffinées

Conçu pour les clients qui sont à la recherche d'une offre fructueuse combiné avec la plus haute qualité, Value Line est un mélange de technologies visant à réduire la consommation d'énergie, améliorer l'efficacité du système de filtration et accélérer les opérations de nettoyage.

performance line



Excellent washing

The best solution even against the toughest dirt, Performance line represents excellence in dishwashing results thanks to its high power and the possibility to personalize washing cycles according to your needs.

L'eccellenza nel lavaggio

Performance è la linea che rappresenta l'eccellenza nelle prestazioni di lavaggio. Il meglio contro ogni tipo di sporco ostinato, grazie alle elevate potenze e alla possibilità di personalizzare i cicli di lavaggio in base al tipo di sporco.

L'excellence dans le lavage

La série Performance représente l'excellence parmi les résultats obtenus dans le nettoyage : contre tous les types de saleté tenace, grâce aux hautes puissances et à la possibilité de personnaliser les cycles de lavage selon la saleté.

The right dishwasher
for every Chef

basic line



B 51



B 51

100% stainless steel

Extremely easy to use: in addition to the ON/OFF switch, this dishwasher is characterized by just one push-button. So, it stands for the right dishwasher even for untrained users and extremely hectic restaurants.

100% acciaio inossidabile

Massima semplicità d'uso: con un solo tasto di comando (oltre a quello di ON/OFF) la lavastoviglie risulta semplice da utilizzare anche ad operatori inesperti. Una soluzione perfetta per locali caratterizzati da un'alta rotazione del personale.

100% acier inoxydable

Facilité d'utilisation : avec un seul bouton (en plus de l'ON / OFF) le lave-vaisselle est très facile à utiliser pour tous les opérateurs, aussi que pour les moins expérimentés. Une solution parfaite pour locale caractérisée par un taux de roulement élevé du personnel.



B 51

mm	mm	mm	mm	Volt/Hz	kW	Program	
a 796 b 660 h 1420	500 x 500	370	395	230 V ~ 1 230 V ~ 3 400 V ~ 3N 50 Hz	6,8	2	1080 max 432 min



Stainless steel washing arms. Their bladed nozzles keep their shape unchanged for years, when compared with plastic solutions on the market, and ensure brilliant, long-lasting results. Their stainless steel filter provides efficient water filtration and better pump protection, because it is not worn away by hot water and detergent.

Bracci di lavaggio in acciaio inox. A differenza delle soluzioni in plastica proposte dai concorrenti, mantengono inalterata la forma dei getti "a lama" anche a distanza di anni, per un perfetto risultato di lavaggio. Il filtro in acciaio inox non viene eroso dall'acqua calda e dal detersivo, per un'efficacia di filtrazione costante nel tempo e una miglior protezione della pompa.

Bras de lavage en acier inox. La forme de jets "à lame" reste inchangée même après beaucoup d'années d'utilisation, tandis que les solutions en plastiques déjà proposées dans le marché sont moins fiables. Le filtre en acier inox n'est pas détérioré par l'eau chaude et le détergent, qui garantit une constante filtration efficace et une meilleure protection de la pompe.



Classy interface with chromed buttons. Led lamps are more visible than standard to better control the machine also from far away.

Elegante interfaccia con pulsanti cromati. Le spie a led, più luminose di quelle tradizionali, permettono di controllare lo stato della macchina anche da distante.

Interface élégante avec des boutons chromés. Les voyants LED, plus lumineuses que les lampes traditionnelles, vous permettent de vérifier l'état de l'appareil, à distance aussi.

value line



AT 901



AT 901

Eco friendly: -40% of water*

AT901 "technological core" is represented by its double water filtration system, which helps you to keep water cleaner. This means that 40% less* water is needed in the washing tank for remarkable energy and detergent savings.

Eco friendly: - 40% di acqua*

Il "cuore tecnologico" della AT901 sta nel doppio sistema di filtrazione, che permette di mantenere l'acqua più pulita. Il suo vantaggio principale è il minor utilizzo di acqua in vasca, ben il 40% in meno*, con un sensibile risparmio di energia e detersivo.

Eco friendly: 40% moins d'eau*

Le centre technologique du modèle AT901 est dans le système de double filtration, qui maintient l'eau propre. L'avantage le plus important est la réduction d'eau dans la cuve de lavage, le 40% en moins*, avec des économies considérables d'énergie et de détergent.

*As compared to model B51 - Rispetto al modello B51 - Par rapport au modèle B51



AT 901

mm	mm	mm	mm	Volt/Hz	kW	Program	
a 760 b 610 h 1440	500 x 500	380	400	230 V ~ 1 230 V ~ 3 400 V ~ 3N 50 Hz	6,8	3	1080 432 + inf



Rounded washing tank edges prevent dirt from being stuck in corners. You will experience quicker cleaning operations and a better smelling dishwasher.

I bordi raggiati della vasca impediscono allo sporco di rimanere intrappolato negli spigoli. La pulizia sarà più veloce e si eviteranno i cattivi odori.

Les bords arrondis de la cuve empêchent que la saleté reste dans les coins. Le nettoyage sera plus rapide et les odeurs désagréables seront évitées.



value line



AT 951



AT 951

Double power

AT951 is the perfect solution against tough dirt. Thanks to its double-powered pump and 50% more powerful heating elements*, it is effective even on dirt-encrusted plates.

Doppia potenza

AT951 è la soluzione ideale contro lo sporco difficile. Equipaggiata con una pompa dalla potenza raddoppiata e con resistenze elettriche incrementate del 50%*, risulta efficace anche su piatti particolarmente incrostanti.

Double puissance

AT951 est la solution idéale contre la saleté tenace. Équipé d'une pompe à puissance doublée et avec une résistance électrique augmentée de 50%*, il est également efficace sur les plaques particulièrement incrustées.

*As compared to model B51 - Rispetto al modello B51 - Par rapport au modèle B51



AT 951

	mm	mm	mm	mm	Volt/Hz	kW	Program	
a	796	500 x 500	370	395	230 V ~ 3 400 V ~ 3N 50 Hz	10,1	3	1080 432 + inf
b	660							
h	1420							



Additional stainless steel surface filter. You can perform cleaning operations more times during the day, so to keep water cleaner.

Filtro superficiale addizionale in acciaio inox. La pulizia può essere quindi fatta frequentemente durante la giornata, mantenendo così l'acqua più pulita.

Filtre de surface supplémentaire en acier inoxydable. Le nettoyage peut donc être effectué fréquemment pendant la journée, ce qui permet de garder l'eau plus propre.



PRP - Perfect Rinse Performance

Available on demand, PRP - Perfect Rinse Performance - ensures water temperature at 82°C during the complete rinsing cycle. It represents a surefire solution for absolute dishes sanitization and quick, efficient drying.

PRP - Perfect Rinse Performance è la tecnologia (optional) che mantiene la temperatura ad 82°C per tutto il ciclo di risciacquo. Una garanzia di sanitizzazione delle stoviglie e di tempi di asciugatura ridotti.

PRP - Perfect Rinse Performance est la technologie (en option), qui maintient la température à 82 °C tout au long du cycle de rinçage. Une garantie de parfaites performances de rinçage avec des temps de séchage réduits et une hygiénisation de la vaisselle.

performance line



AT 1001



AT 1001

Productive while saving energy

Does the right mix between high productivity and remarkable energy savings exist? Yes, and model AT1001 is the answer. You can wash up to 1100 plates/hour and save energy and detergent thanks to its 20lt. washing tank.

Veloce ed ecologica

Si può ottenere il giusto bilanciamento tra un'elevata produttività e il massimo risparmio energetico? Sì, con AT1001. Il modello che permette di lavare fino a 1100 piatti/ora, e che risparmia energia e detersivo utilizzando una vasca di soli 20 Lt d'acqua.

Vitesse et économie

Est-ce que vous pouvez obtenir le juste équilibre entre une forte productivité et des économies d'énergie? Oui, la réponse est le modèle AT 1001. Il peut laver jusqu'à 1100 assiettes / heure et économise l'énergie et le détergent en utilisant une cuve à 20 litres d'eau seulement.



AT 1001

	mm	mm	mm	mm	Volt/Hz	kW	Program	
a	760	500 x 500	380	400	230 V ~ 3 400 V ~ 3N 50 Hz	6,8	8	1080 max 108 min
b	610							
h	1440							



Highly resistant and anti-scratch capacitive display, designed to bear with any modern kitchens stress.

Display capacitivo antigraffio e resistente agli urti, studiato per resistere all'utilizzo frenetico delle cucine professionali.

Affichage résistant aux rayures et aux chocs, conçu pour résister à l'utilisation frénétique des appareils professionnels.

Only 2,5 lt. of water required for each washing cycle for best-in-class energy savings.

Solo 2,5Lt di consumo d'acqua per ciclo di lavaggio. Risparmio energetico ai vertici della categoria.

Consommation de 2,5 Lt seulement d'eau par cycle de lavage. Les économies d'énergie les plus hautes dans la catégorie.



performance line



AT 1201



AT 1201

Best wash

Brilliant washing results against every type of dirt. AT1201 combines above average power to a Custom cycle, which can be set to match different crockery, stains or inlet water conditions.

Il miglior lavaggio

Combinando la sua elevata potenza al ciclo personalizzato, adattabile al tipo di sporco e di acqua presente in ingresso, si può ottenere con AT1201 la migliore prestazione di lavaggio contro ogni tipo di sporco.

Le lavage le meilleur

La combinaison de la puissance élevée de la pompe avec la gestion électronique des cycles de lavage, qui s'adapte au type de saleté et à l'eau à l'entrée, donne au modèle AT 1201 la meilleure performance de lavage contre tous les types de saleté.



AT 1201

	mm	mm	mm	mm	Volt/Hz	kW	Program	
a	796	500 x 500	370	395	230 V ~ 3 400 V ~ 3N 50 Hz	10,1	8	1080 max 108 min
b	660							
h	1420							



Thanks to its double-powered pump and 50% more powerful heating elements*, it is the perfect solution against tough dirt and dirt-encrusted plates.

Ideale contro lo sporco difficile o su piatti incrostati, grazie alla potenza della pompa raddoppiata e alle resistenze elettriche incrementate del 50%.*

Idéal contre la saleté tenace ou de assiettes incrustés, grâce à la puissance doublée de la pompe et aux résistances électriques augmentées de 50%.*

*As compared to model B51 - *Rispetto al modello B51 - Par rapport au modèle B51*

performance line



AT 1401



AT 1401

Cutting edge technology

Unique 2 boilers solution system, allowing operations in case of a heater failure until Service is completed. Preheat boiler guarantees 80°C rinsing water temperature.

Tecnologia all'avanguardia

L'unica lavastoviglie con 2 boiler. Il boiler aggiuntivo di preriscaldamento mantiene la temperatura di risciacquo ad 80°C, e permette di continuare a lavorare in caso di anomalia a una resistenza, in attesa dell'uscita del tecnico.

Technologie d'avenir

Le seul modèle avec 2 surchauffeurs. Le surchauffeur de préchauffage supplémentaire maintient la température de rinçage à 80°C et permet de continuer à laver même en cas d'anomalie de la résistance, dans l'attente du service d'assistance.



AT 1401

	mm	mm	mm	mm	Volt/Hz	kW	Program	
a	790	500 x 500	385	405	230 V ~ 3 400 V ~ 3N 50 Hz	9,2	8	1080 max 108 min
b	660							
h	1440							



HD Full-touch display with colored icons. The most intuitive and easy to use.

Il Full-Touch display in HD ad icone colorate è intuitivo e più facile da usare.

L'affichage Full-Touch HD avec icônes colorées est intuitif et facile à utiliser.



Double-skinned, insulated washing tank increases your comfort, thanks to lower noise and remarkable energy savings.

La vasca in doppia parete con isolamento aumenta il confort dell'operatore riducendo la rumorosità, e migliora ulteriormente i consumi energetici.

La cuve à double parois avec isolation est très confortable pour l'opérateur en réduisant le bruit, en plus la consommation d'énergie est améliorée encore.

*As compared to model B51 - *Rispetto al modello B51 - Par rapport au modèle B51*





professional dishwashers

ATA srl

Viale del Progresso, 20 - ZI
35026 Conselve (Padova) - Italy
Tel. +39 049 9500555
Fax. +39 049 9500560
mail@atasrl.com
www.atasrl.com





Lavavajillas de capota

Капотные посудомоечные машины /
Durchschubspülmaschinen





Hazlo posible con ATA connect.

Imagina que el técnico mismo entre en tu restaurante y te pida de poder revisar el lavavajillas, en lugar de tener que llamarlo. Imagina que el técnico conozca el problema de tu lavavajillas incluso antes de verlo y que pueda repararlo rápidamente, ya teniendo el repuesto correcto. Ahora es posible con nuestros lavavajillas WiFi.



Сделайте это возможным при помощи ATA connect.

Представьте себе, что техник-специалист входит в ваш ресторан и просит разрешения проверить вашу посудомоечную машину, и вам даже не пришлось его вызывать. Представьте себе, что техник-специалист знает, что именно неисправно в вашей посудомоечной машине, ещё до того, как увидит саму машину, он сможет быстро её наладить, и у него всегда найдётся подходящая запчасть. Теперь это стало возможным с нашими посудомоечными машинами с WiFi.

Machen Sie es möglich mit ATA Connect.

Stellen Sie sich vor, der Techniker betritt Ihr Restaurant und bittet Sie, den Geschirrspüler zu überprüfen, anstatt dass Sie ihn anrufen müssen. Stellen Sie sich vor, der Techniker kennt das Problem Ihres Geschirrspülers, schon bevor er ihn sich angesehen hat, und er kann sie schnell reparieren, wobei er immer das richtige Ersatzteil dabei hat. Das ist jetzt mit unseren WLAN-Geschirrspülmaschinen möglich.

Las nuevas funcionalidades a tu servicio /
Новая функциональность - к вашим услугам /
Neue Funktionen zu Ihren Diensten



Control remoto

Siempre conectado a tu centro de asistencia, para que te sientas cómodo.

Удалённая проверка

Постоянно на связи с вашим Центром технической помощи, ради вашего спокойствия.

Steuerung über Fernbedienung

Immer mit Ihrem Kundendienstzentrum verbunden, damit Sie sich um nichts sorgen müssen



Mantenimiento preventivo

Informes de mantenimiento periódico, para evitar paradas de la máquina.

Профилактическое техобслуживание

Сообщения о периодическом техобслуживании, чтобы избежать простоев оборудования.

Vorbeugende Wartung

Berichterstattung über regelmäßige Wartungen, um Maschinenstillstände zu vermeiden.



Envío de mensajes de error

Comunicación de problemas vía WiFi, para un mantenimiento más rápido.

Отправка сообщений об ошибке

Передача информации о неисправности через WiFi, для более быстрого ремонта

Senden von Fehlermeldungen

Kommunikation von Problemen über WLAN für eine schnellere Wartung.



Programación de ciclos remotos

Cambio de parámetros de lavado más rápido y más barato.

Удалённое программирование циклов мойки

Изменение параметров для более быстрой и экономичной мойки.

Remote-Zyklusprogrammierung

Schnellere und wirtschaftlichere Änderungen der Spülparameter.

ATA connect

Disfrutes del mejor servicio de asistencia técnica del mercado con ATA Connect, el sistema que combina la tecnología de transmisión de datos WiFi con un código QR de asistencia. Tu técnico puede monitorear el lavavajillas a distancia y la máquina le envía señales de error, a veces incluso antes de que hayas notado el problema.

También aconseja al técnico cuándo realizar el mantenimiento preventivo, para que pueda programarse cuando el local no esté abierto al público y evitar tiempos de inactividad durante el servicio.

¿No está satisfecho con los 8 ciclos de lavado preestablecidos? ¿El lavavajillas ya no lava bien después de cambiar la marca de detergente? No te preocupes: tu técnico podrá cambiar los parámetros del ciclo de forma remota y rápida.

Finalmente, puedes concentrarte en lo que más amas hacer: cuidar de tus clientes.

Наслаждайтесь наилучшей на рынке Службой технической помощи ATA Connect, которая сочетает WiFi технологию передачи данных со службой QR-кода. Посудомоечная машина удалённо отслеживается вашим техником-специалистом, машина сама отправляет технику сообщения при возникновении ошибок, иногда даже раньше, чем вы заметили проблему.

Кроме того, машина подсказывает технику, когда требуется провести профилактическое техобслуживание, чтобы спланировать его на то время, когда заведение закрыто для публики и избежать простоев машины во время работы.

Вы не удовлетворены 8-ю предустановленными моечными циклами? Посудомоечная машина перестала хорошо мыть после смены марки моющего средства? Не беспокойтесь: ваш техник в кратчайшее время сможет удалённо изменить параметры цикла.

Наконец-то вы сможете сосредоточиться на том, чем вам больше нравится заниматься: обслуживанием ваших клиентов.

Mit ATA Connect, dem System, das die WLAN-Datenübertragungstechnologie mit einem Service-QR-Code kombiniert, können Sie den besten technischen Support auf dem Markt genießen. Der Geschirrspüler wird von Ihrem Techniker fernüberwacht und sendet die Fehlermeldungen manchmal sogar noch bevor Sie das Problem bemerkt haben.

Sie weist den Techniker auch darauf hin, wenn vorbeugende Wartungsarbeiten anstehen, damit diese programmiert werden können, wenn das Lokal nicht für die Öffentlichkeit zugänglich ist, und um Ausfallzeiten der Maschine während der Wartung zu vermeiden.

Genügen Ihnen die 8 voreingestellten Spülzyklen nicht? Spült der Geschirrspüler nach einem Wechsel der Spülmittelmarke nicht mehr richtig? Keine Sorge: Ihr Techniker kann die Zyklusparameter aus der Ferne schnell ändern.

Endlich können Sie sich auf das konzentrieren, was Sie am liebsten tun: sich um Ihre Gäste kümmern.



Video disponible en www.atasrl.com
Видео доступно на сайте: www.atasrl.com
Video auf www.atasrl.com verfügbar

ATA advantages



Auto-clean

Un ciclo de autolimpieza reduce el tiempo y el costo de la limpieza del lavavajillas.

Цикл самоочистки позволяет сократить время и стоимость чистки посудомоечной машины.

Ein Selbstreinigungszyklus reduziert die Zeit und die Kosten für die Reinigung des Geschirrspülers.



PRP - Perfect Rinse Performance

Enjuague a 82 °C y a presión constante, para desinfectar las vajillas y reducir los tiempos de secado.

Ополаскивание при температуре 82°C и с постоянным давлением, для санитарной обработки посуды и сокращения времени сушки.

Nachspülung auf 82°C und konstanten Druck für die Desinfektion des Geschirrs und verkürzte Trocknungszeiten.



Thermolock System

Asegura la perfecta higienización de los vasos, gracias a que el ciclo de enjuague solo se hace con agua a 82°C.

Thermolock - это система, обеспечивающая санитарную обработку посуды, поскольку позволяет ополаскивать её лишь водой температурой не ниже 82°C.

Thermolock ist das System, das die Desinfektion von Geschirr garantiert, da es das Nachspülen nur mit 82° C heißem Wasser zulässt.



Smart Dispenser

Sistema de dosificación inteligente del detergente (opcional), detecta la cantidad de suciedad y dispensa la dosis justa de detergente.

Система "умного" дозирования моющего средства (опция), которая "чувствует" грязь и выдаёт строго необходимое количество моющего средства.

Intelligentes Dosiersystem für das Geschirrspülmittel (optional), das den Schmutz „fühlt“ und nur die benötigte Menge ausgibt.



Plates

El ciclo más versátil para diferentes tipos de suciedad, como grasas, proteínas o almidones.

Наиболее гибкий цикл для загрязнений различного типа, таких, как жир, белок или крахмал.

Der vielseitigste Spülgang für verschiedene Schmutzarten wie Fette, Proteine oder Stärken.



Glasses

Vasos secos y brillantes con un ciclo de lavado corto combinado con un enjuague suave.

Сухие и блестящие стаканы с коротким циклом мойки, в сочетании с нежным ополаскиванием.

Trockene und glänzende Gläser mit einem kurzen Waschgang, kombiniert mit sanftem Abspülen.



Cutlery

Los cubiertos se pueden lavar a altas temperaturas para eliminar mejor la suciedad sin deteriorarlos.

Столовые приборы можно мыть при высокой температуре, чтобы лучше удалить загрязнения, без повреждения приборов.

Besteck kann bei hohen Temperaturen gewaschen werden, um Schmutz gründlich zu entfernen, ohne es zu beschädigen.



Sanitization

Un mayor tiempo de lavado, a temperaturas más altas, para desinfectar la vajilla.

Большее время мойки, при более высокой температуре, для санитарной обработки посуды.

Eine längere Waschzeit bei höheren Temperaturen, um das Geschirr zu desinfizieren.



Pots

Un ciclo más largo para objetos muy sucios e incrustados.

Наиболее долгий цикл для очень грязных предметов с накипью (коркой).

Ein längerer Zyklus für stark verschmutzte und verkrustete Utensilien.



Fragile glasses

La función soft-start evita roturas a los flutes.

Функция мягкого старта позволяет избежать раскола фужеров.

Die Softstart-Funktion vermeidet Brüche von empfindlichen Sektdgläsern.



Custom

Eliges tu las temperaturas y tiempos de lavado.

Вы сами выбираете температуру и время мойки. Wählen Sie selbst die Temperaturen und Waschzeiten.



Eco clean

Ciclo de ahorro de energía. Ciclo с экономией энергии. Energiesparzyklus.

ATA technology

El código QR de Asistencia proporciona a nuestros socios técnicos toda la información necesaria para una instalación correcta, como el Manual y los diagramas de conexión. Cada centro de asistencia autorizado por ATA puede acceder a la lista de repuestos del lavavajillas. De este modo, puede identificar rápidamente el componente a reemplazar y solicitarlo en tiempo real desde el teléfono, sin errores y en solo 3 simples pasos.

Служба QR-кода даёт нашим партнёрам – техникам всю информацию, необходимую для правильной установки оборудования, т.е. Руководства и Схемы подключения. Каждый Авторизованный сервисный центр фирмы ATA может получить доступ к списку запчастей посудомоечной машины. Таким образом, Сервисный центр может быстро определить часть, требующую замены, и заказать её в реальном времени с сотового телефона, безошибочно и всего лишь за 3 простых шага.

Mit dem Service-QR-Code erhalten unsere technischen Partner alle Informationen, die für eine ordnungsgemäße Installation erforderlich sind, z. B. das Handbuch und die Anschlusspläne. Jedes zugelassene ATA-Service-Center kann auf die Ersatzteilliste für Geschirrspüler zugreifen. So kann es die auszutauschende Komponente schnell identifizieren und in Echtzeit fehlerfrei und in nur 3 einfachen Schritten über das Telefon bestellen.

step 1

Veas el código QR con la cámara del teléfono, para ser redirigido automáticamente a nuestro sitio web.

Навести на QR-код камеру сотового телефона, автоматически произойдёт перенаправление на наш интернет-сайт.

Erfassen Sie den QR-Code mit der Kamera des Telefons, um automatisch auf unsere Website umgeleitet zu werden.

step 2

Abras la lista de piezas del lavavajillas y seleccione las que desea reemplazar.

Открыть список запчастей посудомоечной машины и выбрать части, требующие замены.

Öffnen Sie die Liste der Ersatzteile für Geschirrspüler und wählen Sie die Teile aus, die ausgetauscht werden sollen.

step 3

Agregue los repuesto al carrito de compras y envíe el pedido con un simple clic.

Добавить запчасти в корзину и отправить заказ одним кликом.

Legen Sie die Ersatzteile in den Warenkorb und senden Sie die Bestellung mit einem einfachen Klick ab.



Video disponible en www.atasrl.com
Видео доступно на сайте: www.atasrl.com
Video auf www.atasrl.com verfügbar



step 1



step 2



step 3



basic line



Robustez y fiabilidad

Resistencia y fiabilidad sin compromiso, garantizadas por los estándares de producción ATA. Soluciones técnicas diseñadas para maximizar la facilidad de uso y reducir los costos de gestión y mantenimiento.

Прочность и надёжность

Бескомпромиссная прочность и надёжность, гарантированные стандартом производства компании ATA. Технические решения, разработанные для максимального упрощения использования и снижения стоимости управления и обслуживания.

Robust und zuverlässig

Robust und zuverlässig ohne Kompromisse, garantiert durch ATA-Produktionsstandards. Technische Lösungen zur Maximierung der Benutzerfreundlichkeit und Reduzierung der Kosten für Verwaltung und Wartung.

value line



Rendimiento y acabados refinados

Diseñada para quien busca una oferta ventajosa combinada con la más alta calidad, la línea Value es un concentrado de tecnologías destinadas a reducir el consumo energético, a mejorar la eficiencia del sistema de filtración y a acelerar las operaciones de limpieza.

Изысканное исполнение и отделка

Эта линия создана для тех, кто ищет выгодное предложение в сочетании с максимальным качеством, Value line - это средоточие технологий, нацеленных на снижение потребления энергии, улучшение эффективности системы фильтрации и ускорение операций по чистке.

Hochwertige Leistungen und Oberflächen raffiniées

Die Value-Linie wurde für Kunden entwickelt, die ein vorteilhaftes Angebot in Verbindung mit maximaler Qualität suchen. Sie ist ein Konzentrat von Technologien, die darauf abzielen, den Energieverbrauch zu senken, die Effizienz des Filtersystems zu verbessern und die Reinigungsvorgänge zu beschleunigen.

performance line



Excelencia en lavado

Performance es la línea que representa la excelencia en el rendimiento de lavado. Lo mejor contra todo tipo de suciedad persistente, gracias a las potencias elevadas y a la posibilidad de personalizar los ciclos de lavado según el tipo de suciedad.

Превосходная мойка

Performance - это линия, обеспечивающая превосходную степень качества мойки. Самая лучшая очистка любых трудноудаляемых загрязнений благодаря высокой мощности и возможности персонализировать циклы мойки в зависимости от типа загрязнения.

Exzellente Spülqualität

Performance ist die Linie, die für hervorragende Spülleistung steht. Das Beste gegen alle Arten von hartnäckigem Schmutz, dank der hohen Leistungsfähigkeiten und der Möglichkeit, die Spülzyklen individuell anzupassen.

El lavavajillas ideal para todos los Chefs

Идеальная посудомоечная машина для каждого шеф-повара

Die ideale Gläserspülmaschine für alle Meisterköche

basic line



B 51



B 51

100% acero inox

Máxima simplicidad de uso: con un solo botón de control (además del botón de ENCENDIDO / APAGADO), el lavavasos es fácil de usar incluso para operadores sin experiencia. Una solución perfecta para locales con alta rotación de personal.

100% нержавеющей сталь

Максимальная простота использования: управление при помощи одной кнопки (помимо кнопки ВКЛ/ВЫКЛ) - посудомоечной машиной просто пользоваться даже неопытным операторам. Идеальное решение для заведений с высокой ротацией персонала.

100 % rostfreier Edelstahl

Höchster Bedienkomfort: Mit nur einer Bedientaste (zusätzlich zur EIN-AUS-Taste) ist die Gläserpülmaschine auch für unerfahrene Personen einfach zu bedienen. Eine perfekte Lösung für Lokale mit hoher Mitarbeiter-Rotation.



B 51



Brazos de lavado en acero inoxidable. A diferencia de las soluciones plásticas que ofrece el mercado, mantienen sin alteraciones la forma de "cuchillo" de los chorros, incluso años más tarde, para un resultado de lavado perfecto. El filtro de acero inoxidable no es erosionado por el agua caliente y el detergente, para una eficiencia de filtrado constante y una mejor protección de la bomba.

Моечные рукава из нержавеющей стали. В отличие от пластмассовых решений, представленных на рынке, они сохраняют неизменной форму "ножевых" струй даже спустя много лет, для достижения идеального результата мойки. Фильтр из нержавеющей стали не корродирует от горячей воды и моющего средства, обеспечивая эффективную фильтрацию, неизменную с течением времени, и лучшую защиту насоса.

Sprüharme aus rostfreiem Edelstahl. Im Gegensatz zu den auf dem Markt angebotenen Kunststoff-Sprühdüsen bleiben die „klingenförmigen“ Düsen über lange Jahre unverändert und es wird immer ein perfektes Spülergebnis erzielt. Der Edelstahlfilter wird durch heißes Wasser und Reinigungsmittel nicht angegriffen und somit ist eine konstante Filtrationseffizienz und ein besserer Schutz der Pumpe gewährleistet.



Interfaz elegante con botones cromados. Las luces LED, más brillantes que las tradicionales, permiten verificar el estado de la máquina incluso a distancia.

Элегантный интерфейс с хромированными кнопками. Светодиодные контрольные лампы, более яркие, чем традиционные, позволяют контролировать состояние машины даже на расстоянии.

Elegante Benutzeroberfläche mit Chromknöpfen. Mit LED-Leuchten, die heller als herkömmliche Leuchten sind, können Sie den Status des Geräts auch aus der Ferne überprüfen.

mm	mm	mm	mm	Volt/Hz	kW	Program	
a 796 b 660 h 1420	500 x 500	370	395	230 V ~ 1 230 V ~ 3 400 V ~ 3N 50 Hz	6,8	2	1080 max 432 min



value line



AT 901



AT 901

Solución ecológica: -40% de agua*

El "corazón tecnológico" de este modelo se encuentra en el sistema de doble filtración, que permite mantener el agua más limpia. Su principal ventaja es el menor uso de agua en la cuba, bien un 40% menos*, con un ahorro significativo de energía y detergente.

Экологичность: -40% воды*

Технологическое "ядро" этой модели заключается в двойной системе фильтрации, позволяющей сохранять воду более чистой. Её основное преимущество - меньшее использование воды в ванне, на целых 40% меньше*, с ощутимой экономией энергии и моющего средства.

Umweltfreundlich: -40% Wasser

Das "technologische Herz" des AT901 ist im Filtersystem, das doppelt ist und das Wasser sauber hält. Sein Hauptvorteil ist der um bis zu 40% geringere Wasserverbrauch im Tank* bei einer deutlichen Einsparung von Energie und Reinigungsmittel.

*comparado con el modelo B51 - относительно модели B51 - im Vergleich zum Modell B51



AT 901



a 760
b 610
h 1440



500 x 500



380



400



230 V ~ 1
230 V ~ 3
400 V ~ 3N
50 Hz



6,8

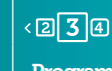

3



1080
432
+ inf



Los bordes redondeados de la cuba evitan que la suciedad quede atrapada en las esquinas. La limpieza será más rápida y se evitarán los olores.

Закруглённые края ванны не позволяют грязи скапливаться в углах. Чистка будет быстрее, отсутствие плохого запаха.

Die abgerundeten Kanten des Spülbeckens verhindern, dass Schmutz in den Ecken bleibt. Die Reinigung erfolgt schneller und Gerüche werden vermieden.



value line



AT 951



AT 951

Doble potencia

AT951 es la solución ideal contra la suciedad difícil. Equipada con una bomba con doble potencia y con resistencias eléctricas aumentadas del 50%*, es eficaz aún con platos muy incrustados.

Двойная мощность

AT951 - это идеальное решение против трудноудаляемой грязи. Оснащённая насосом удвоенной мощности и электрическими ТЭНами, усиленными на 50%*, машина эффективно моет даже тарелки, полностью покрытые коркой.

Doppelte Leistung

AT951 ist die ideale Lösung gegen schwierigen Schmutz. Ausgestattet mit einer Pumpe mit doppelter Leistung und einem um 50% erhöhten elektrischen Widerstand * ist das Modell AT951 auch bei besonders dreckigem Geschirr wirksam.

*comparado con el modelo B51 - относительно модели B51 - im Vergleich zum Modell B51



AT 951

mm	mm	mm	mm	Volt/Hz	kW	Program	
a 796 b 660 h 1420	500 x 500	370	395	230 V ~ 3 400 V ~ 3N 50 Hz	10,1	3	1080 432 + inf



Filtro de superficie adicional en acero inoxidable. Por lo tanto, la limpieza se puede hacer con frecuencia durante el día, manteniendo así el agua más limpia.

Дополнительный наружный фильтр из нержавеющей стали. Чистка может часто производиться в течение дня, что сохраняет воду более чистой.

Zusätzlicher Oberflächensieb aus Edelstahl. Die Reinigung kann daher tagsüber häufig erfolgen, wodurch das Wasser sauberer bleibt.



PRP - Perfect Rinse Performance

PRP - Perfect Rinse Performance - es la tecnología (opcional) que mantiene la temperatura a 82 °C durante todo el ciclo de enjuague. Una garantía de saneamiento de las vajillas y de tiempos reducidos de secado.

PRP - Perfect Rinse Performance – это технология (опция), поддерживающая температуру на 82°C в течение всего цикла ополаскивания. Это обеспечивает санитарную обработку посуды и сокращённое время сушки.

PRP - Perfect Rinse Performance - ist die Technologie (optional), die die Temperatur während des gesamten Spülzyklus auf 82 °C hält. Eine Garantie für die Desinfektion des Geschirrs und verkürzte Trocknungszeiten.

performance line



AT 1001



AT 1001

Rápido y ecológico.

¿Se puede lograr el equilibrio correcto entre alta productividad y máximo ahorro de energía? Sí, con AT1001.

El modelo que permite lavar hasta 1100 platos/hora, y que ahorra energía y detergente utilizando una cuba de solo 20 Lt de agua.

Быстрая и экологичная

Можно ли добиться правильного баланса между высокой производительностью и максимальной экономией энергии? Да, с машиной AT1001. Данная модель позволяет мыть до 1100 тарелок в час, и она экономит энергию и моющее средство, поскольку ванна рассчитана всего лишь на 20 л. воды.

Schnell und umweltfreundlich

Kann das richtige Gleichgewicht zwischen hoher Produktivität und maximaler Energieeinsparung erreicht werden? Ja, mit dem AT1001. Dieses Modell kann bis zu 1100 Teller pro Stunde spülen und durch seinen Tank mit nur 20 Litern Wasser Energie und Reinigungsmittel sparen.



AT 1001

	mm	mm	mm	mm	Volt/Hz	kW	Program	
a	760	500 x 500	380	400	230 V ~ 3 400 V ~ 3N 50 Hz	6,8	8	1080 max 108 min
b	610							
h	1440							



Pantalla capacitiva resistente a los arañazos y a los impactos, diseñada para resistir el uso frenético de las cocinas profesionales.

Ёмкостный царапиноустойчивый и ударопрочный дисплей разработан специально для использования в "лихорадочной" атмосфере профессиональной кухни.

Kratzfeste und schlagfeste Kapazitätsanzeige, die dem hektischen Einsatz gewerblicher Küchen standhält.

Solo 2,5 Lt de consumo de agua por ciclo de lavado. Ahorro de energía a la cima de su categoría.

Vsего лишь 2,5 л расхода воды на цикл мойки. Максимальная экономия энергии для данной категории.

Nur 2,5 l Wasserverbrauch pro Waschgang. Energieeinsparung an der Spitze der Kategorie.



performance line



AT 1201



AT 1201

El mejor lavado

Combinando su alta potencia con el ciclo personalizado, adaptable al tipo de suciedad y de agua en entrada, con AT1201 es posible obtener el mejor rendimiento de lavado contra todo tipo de suciedad.

Наилучшая мойка

Сочетая высокую мощность с персонализированным циклом, который можно изменять в зависимости от типа загрязнения и типа воды на входе, с машиной AT1201 можно получить наилучшие показатели мойки загрязнений любого типа.

Die optimale Spülung

Die Kombination von seiner hohen Leistung mit dem kundenspezifischen Zyklus, der an die Art des Schmutzes und des Wassers angepasst werden kann, können Sie AT1201 die beste Waschleistung gegen alle Arten von Schmutz erzielen.

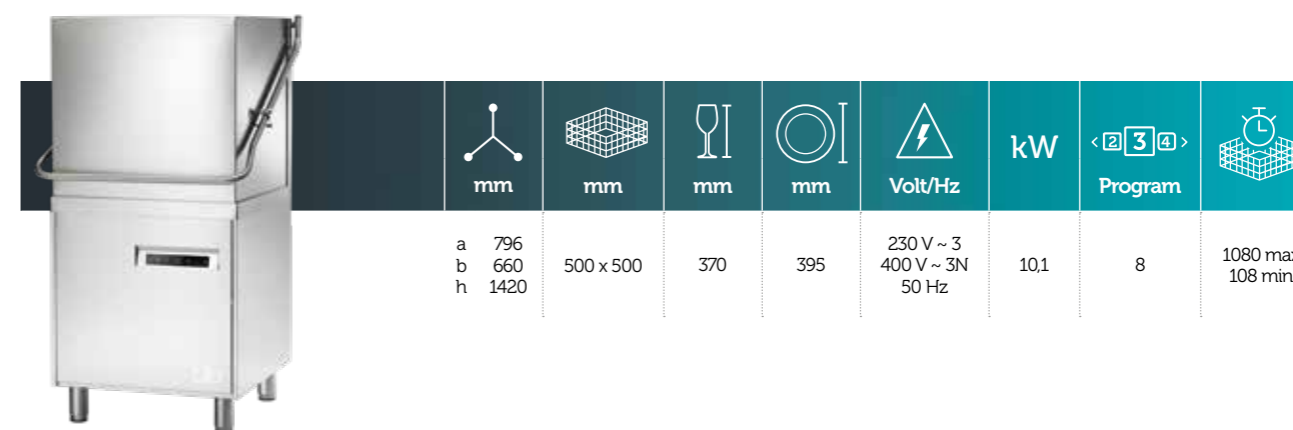

AT 1201



a 796
b 660
h 1420



500 x 500



370



395



230 V ~ 3
400 V ~ 3N
50 Hz

kW

10,1

< 2 3 4 >

Program

8



1080 max
108 min



Ideal contra suciedad difícil o en platos incrustados, gracias a la doble potencia de la bomba y a las resistencias eléctricas aumentadas del 50%*.

Идеально против стойких загрязнений и для тарелок с твёрдым налётом, благодаря удвоенной мощности насоса и усиленным на 50%* электрическим ТЭНам.

Ideal gegen schwierigen Schmutz oder verkrustete Teller, dank der doppelten Pumpleistung und der um 50% erhöhten elektrischen Widerstände*.

*comparado con el modelo B51 - относительно модели B51 - im Vergleich zum Modell B51

performance line



AT 1401



AT 1401

Tecnología de vanguardia

El único lavavajillas con 2 calderas. La caldera adicional de precalentamiento mantiene la temperatura de enjuague a 80 °C, y permite continuar trabajando en caso de anomalía en una de las resistencias, a la espera del técnico.

Передовая технология

Единственная посудомоечная машина с 2-мя бойлерами. Дополнительный бойлер предварительного нагрева поддерживает температуру ополаскивания 80 °C, позволяя продолжить работу в случае неисправности одного из ТЭНов, в ожидании прихода техника.

Spitzentechnologie

Die einzige Spülmaschine mit 2 Boilern. Der zusätzliche Vorheizboiler hält die Spültemperatur auf 80 °C, damit Sie weiterarbeiten können und auf den Kundendienst warten, auch im Falle einer Störung an einem Widerstand.



AT 1401



mm

a 790
b 660
h 1440



mm

500 x 500



mm

385



mm

405



Volt/Hz

230 V ~ 3
400 V ~ 3N
50 Hz

kW

9,2

Program

8



1080 max
108 min



La pantalla Full-Touch HD con iconos de colores es intuitiva y más fácil de usar.

Полностью сенсорный HD дисплей с цветными пиктограммами - интуитивный и более простой в использовании.

Das Full-Touch HD-Display mit farbigen Symbolen ist intuitiv und einfacher zu bedienen.



La cuba de doble pared con aislamiento aumenta la comodidad del operador, al reducir el ruido, y mejora aún más el consumo de energía.

Ванна с двойной стенкой с теплошумоизоляцией увеличивает комфорт оператора, снижая шум, и даёт ещё большую экономию энергии.

Der doppelwandige Tank mit Isolierung erhöht den Bedienerkomfort, indem er Geräusche reduziert und den Energieverbrauch weiter verbessert.





ATA srl

Viale del Progresso, 20 - ZI
35026 Conselve (Padova) - Italy
Tel. +39 049 9500555
Fax. +39 049 9500560
mail@atasrl.com
www.atasrl.com





Front-loading dishwashers

Lavastoviglie a carico frontale /

Lave-vaisselle frontales



Make it real with ATA connect

Imagine a Service Partner entering your restaurant and asking you to check your dishwasher, instead of you asking for a visit. Imagine a Service Partner that can fix your dishwasher problem quickly, instead of leaving with it standing idle and waiting to be fixed in your busy restaurant. This is now possible with WiFi connected dishwashers.

Rendilo possibile con ATA connect.

Immagina che sia il Tecnico ad entrare nel tuo ristorante e chiederti di controllare la lavastoviglie, invece di essere tu a doverlo chiamare. Immagina che il Tecnico conosca il problema della tua lavastoviglie ancora prima di vederla, e che la possa riparare velocemente, avendo sempre già con sé il ricambio corretto. Ora è possibile con le nostre lavastoviglie WiFi.

Maintenant il est possible avec ATA connect.

Imaginez que votre technicien entre dans votre restaurant et il vous demande de vérifier le lave-vaisselle. Imaginez que le technicien connaisse quel est le souci de votre lave-vaisselle avant même de le voir et qu'il puisse le réparer rapidement. C'est maintenant possible avec nos lave-vaisselles WiFi.

A world of new possibilities to support you /
Le nuove funzionalità al tuo servizio /
Les nouvelles fonctionnalités à votre service



Remote monitoring

Always connected to your Service Partner for your peace of mind.

Controllo da remoto

Sempre connessa al tuo Centro Assistenza, così puoi stare tranquillo.

Télécommande

Toujours connecté à votre centre d'aide pour que vous puissiez vous sentir à l'aise.



Alarm warning

Remote alert notice for faster problem solving.

Invio dei messaggi di errore

Comunicazione dei problemi via WiFi, per una manutenzione più rapida.

Envoi de messages d'erreur

Communication des problèmes via WiFi, pour une maintenance plus rapide.



Remote setting

Faster cycle parameter change. No Service charge.

Programmazione dei cicli da remoto

Modifica dei parametri di lavaggio più veloce ed economica.

Programmation à distance des cycles

Changement plus rapide des paramètres de lavage.



Preventive maintenance

Periodic check alert to prevent dishwasher downtime.

Manutenzione preventiva

Segnalazione delle manutenzioni periodiche, per evitare fermi macchina.

Maintenance préventive

Rapport de maintenance périodique, pour éviter les temps d'arrêt de la machine.



ATA connect

Enjoy the best Service Experience in the market with ATA Connect, our technology combining a WiFi data transmission system to a Service QR code. Your dishwasher is 24/7 connected to your Service Partner, who can control it by remote. He can also receive Alarm alerts in real time, sometimes even before you might be aware of any problem.

The dishwasher can also recommend your Service Partner a preventive service check, when needed. Therefore, you can plan it during low workload timing, and reduce the risk of failures when the location is busy.

Not satisfied about the 8 pre-set programs? The dishwasher is not washing well after changing your chemical brand? Not a problem: your Service Manager can change your cycle settings from remote, quickly and without charging the cost of a visit.

You can finally focus on what you care the most: your customers.

Goditi il miglior Servizio di Assistenza Tecnica sul mercato con ATA Connect, il sistema che combina la tecnologia WiFi di trasmissione dati ad un Service QR code. La lavastoviglie è costantemente monitorata da remoto dal tuo tecnico, e gli invia eventuali segnali di errore, a volte persino prima che tu ti sia accorto del problema.

Inoltre, consiglia al tecnico quando fare la manutenzione preventiva, così da poterla programmare quando il locale non è aperto al pubblico ed evitare fermi macchina durante il servizio.

Non sei soddisfatto degli 8 cicli di lavaggio pre-impostati? La lavastoviglie non lava più bene dopo aver cambiato la marca di detersivo? Non ti preoccupare: il tuo tecnico potrà cambiare i parametri di ciclo da remoto, velocemente e senza farti pagare l'uscita.

Finalmente puoi concentrarti su quello che ami fare di più: prenderti cura dei tuoi clienti.

Profitez de la meilleure technologie d'assistance technique disponible sur le marché avec ATA Connect, le système combine la transmission de données WiFi à un service de code QR. Le lave-vaisselle est surveillé à distance de votre service technique et envoi des signaux d'erreur, parfois avant que vous même aviez remarqué le souci.

Il indique également au technicien à quel moment effectuer la maintenance préventive, afin de pouvoir la programmer lorsque votre activité n'est pas ouverte au public et d'éviter d'arrêter l'appareil pendant le service.

Pas satisfait des 8 cycles de lavage pré-réglés? Le lave-vaisselle ne lave pas aussi bien après avoir changé la marque de détergent? Ne vous inquiétez pas: votre technicien peut modifier les paramètres du cycle à distance.

Enfin, vous pouvez vous concentrer sur ce que vous aimez le plus: prendre soin de vos clients.



Video available on www.atasrl.com
Video disponibile su www.atasrl.com
Vidéo disponible sur www.atasrl.com

ATA advantages



Auto-clean

An auto-clean cycle can be selected after use to reduce the hassle & cost of manual washing.

Un ciclo di auto-pulizia permette di ridurre il tempo e il costo di pulizia della lavastoviglie.

Un cycle d'autonettoyage réduit le temps et les coûts de nettoyage.



Water softener

Resin regeneration is programmed during washing cycles with our state-of-the-art built in water softener (models ending with D). No idle time.

Il nostro addolcitore (modelli che terminano con D) di ultima generazione rigenera le resine durante il ciclo di lavaggio, senza fermi macchina.

Notre adoucisseur (modèles avec D) dernière génération régénère les résines pendant le cycle de lavage, sans temps d'arrêt.



Thermolock System

Thermolock system ensures dishes sanitization because the rinsing cycle only starts when water is at 82°C.

Thermolock è il sistema che garantisce la sanitizzazione dei bicchieri, perché non permette di risciacquare se non con acqua ad 82°C.

Le système 'Thermolock' garantit la parfaite hygiène de la vaisselle car le cycle de rinçage commence seulement quand l'eau est à 82°C.



Smart Dispenser

Smart dosing system – available on demand – that "feels" dirt level and pours in only the needed detergent when it is needed.

Sistema di dosaggio intelligente del detersivo (optional), che 'sente' lo sporco e ne immette solo la quantità necessaria.

Système de dosage intelligent de détergent qui capte le degré de la saleté et ne diffuse que la quantité requise.



Plates

Most flexible cycle for different kind of stains like grease, oil or starches.

Il ciclo più versatile per differenti tipi di sporco come grassi, proteine o amidi.

Le cycle le plus polyvalent pour différents types de saleté tels que les graisses, les protéines ou les amidons.



Glasses

Short washing cycle combined to a gentle rinsing, for perfectly dry and shining result.

Bicchieri asciutti e brillanti con un ciclo di lavaggio corto abbinato a un risciacquo delicato.

Verres séchés et brillants avec un cycle de lavage court combiné à un rinçage doux.



Cutlery

Washed & rinsed at high temperature, cutlery can shine without being deteriorated.

Le posate possono essere lavate ad alte temperature per rimuovere meglio lo sporco, senza deteriorarle.

Les couverts peuvent être lavés à haute température pour mieux enlever la saleté, sans les endommager.



Sanitization

Higher temperature and longer washing time can sanitize your crockeries.

Un maggior tempo di lavaggio a temperature più alte per sanitizzare le stoviglie.

Un temps de lavage plus long et des températures plus élevées.



Pots

Longer cycle for heavily soiled crockeries.

Un ciclo più lungo per oggetti molto sporchi e incrostati.

Un cycle plus long pour les ustensiles très sales et incrustés.



Fragile glasses

Soft washing start function available to prevent shocks on flutes.

La funzione soft-start evita rotture ai flutes.

La fonction de démarrage progressif empêche de casser les flûtes.



Custom

You can chose your ideal washing time & temperature.

Scegli tu le temperature e i tempi di lavaggio.

C'est à vous le choix de la température et du temps de lavage.



Eco clean

Energy saving cycle.

Ciclo a risparmio energetico.

Cycle d'économie d'énergie.

ATA technology

Do not worry about After Sale Service!
Service QR code provides technicians with all the information needed for a correct installation, such as Manual and Installation drawings.

ATA authorized Service Partner can access the correct spare part list and quickly identify which part he needs. He can then order it in real time from his mobile phone, without mistakes and in only 3 simple steps.

Non preoccuparti più per il Servizio Post-Vendita!
Il Service QR code fornisce ai Centri Assistenza tutte le informazioni necessarie per una corretta installazione, come il Manuale e gli Schemi di collegamento.
Ogni Centro Assistenza autorizzato da ATA può accedere alla lista dei ricambi della lavastoviglie. Può così identificare velocemente il componente da sostituire e ordinarlo in tempo reale dal telefonino, senza errori e in solo 3 semplici passi.

Le Service QR code offre à nos partenaires techniques toutes les informations nécessaires pour une installation correcte, tels que les manuels et les diagrammes de connexion. Chaque centre de service autorisé par ATA peut accéder à la liste de rechange. Il peut donc identifier rapidement le composant à remplacer et le commander en temps réel à partir du téléphone mobile, sans erreurs et en seulement 3 étapes simples.

step 1

Scan Service QR code with your phone camera to automatically access to our website.

Visualizza il QR code con la fotocamera del telefonino, per essere indirizzato automaticamente al nostro sito web.

Visualisez le code QR avec l'appareil photo du téléphone pour être automatiquement dirigé vers notre site Web.

step 2

Enter the spare part list and select the one you want to replace.

Apri la lista dei ricambi della lavastoviglie e seleziona quelli da sostituire.

Ouvrez la liste des pièces de rechange et sélectionnez celles à remplacer.

step 3

Add it to the basket and order it with the click of a button.

Aggiungi i ricambi al carrello e invia l'ordine con un semplice click.

Ajoutez les pièces de rechange au panier d'achat et envoyez la commande en un simple clic.



Video available on www.atasrl.com
Video disponibile su www.atasrl.com
Vidéo disponible sur www.atasrl.com



step 1



step 2



step 3

basic line



Sturdiness and reliability

Sturdiness and reliability without compromise thanks to ATA high quality standards. Easy to use technical solutions, focused on running and service cost reduction.

Robustezza e affidabilità

Robustezza e affidabilità senza compromessi, garantite dagli standard di produzione ATA. Soluzioni tecniche studiate per massimizzare la semplicità di utilizzo e ridurre i costi di gestione e manutenzione.

Structure robuste et fiable

Structure robuste et fiable sans compromis est garantie par la production standard de ATA. Solutions techniques qui sont faciles à utiliser et économiques dans la gestion et l'entretien.

value line



Premium performance and finishing

Designed for people looking for profitable offers and excellent quality, Value line stands for the right mix of technological solutions for reducing energy consumption, improving water filtration efficiency and speeding up cleaning operations.

Prestazioni e finiture raffinate

Pensata per chi ricerca un'offerta vantaggiosa abbinata alla massima qualità, Value line è un concentrato di tecnologie mirate a ridurre il consumo energetico, a migliorare l'efficienza del sistema di filtrazione e a velocizzare le operazioni di pulizia.

Rendement et finitions raffinées

Conçu pour les clients qui sont à la recherche d'une offre fructueuse combiné avec la plus haute qualité, Value Line est un mélange de technologies visant à réduire la consommation d'énergie, améliorer l'efficacité du système de filtration et accélérer les opérations de nettoyage.

performance line



Excellent washing

The best solution even against the toughest dirt, Performance line represents excellence in dishwashing results thanks to its high power and the possibility to personalize washing cycles according to your needs.

L'eccellenza nel lavaggio

Performance è la linea che rappresenta l'eccellenza nelle prestazioni di lavaggio. Il meglio contro ogni tipo di sporco ostinato, grazie alle elevate potenze e alla possibilità di personalizzare i cicli di lavaggio in base al tipo di sporco.

L'excellence dans le lavage

La série Performance représente l'excellence parmi les résultats obtenus dans le nettoyage : contre tous les types de saleté tenace, grâce aux hautes puissances et à la possibilité de personnaliser les cycles de lavage selon la saleté.

The right dishwasher
for every Chef

basic line



B 31 – 31D*



B 31

100% stainless steel

Extremely easy to use: in addition to the ON/OFF switch, this dishwasher is characterized by just one push-button. Therefore, it stands for the right dishwasher even for untrained users and extremely hectic restaurants.

100% acciaio inossidabile

Massima semplicità d'uso: con un solo tasto di comando (oltre a quello di ON/OFF) la lavastoviglie risulta semplice da utilizzare anche ad operatori inesperti. Una soluzione perfetta per locali caratterizzati da un'alta rotazione del personale.

100% acier inoxydable

Facilité d'utilisation : avec un seul bouton (en plus de l'ON / OFF) le lave-vaisselle est très facile à utiliser pour tous les opérateurs, aussi que pour les moins expérimentés. Une solution parfaite pour locale caractérisée par un taux de roulement élevé du personnel.

B 31
B 31 D*

B 31



Stainless steel washing arms.

Their bladed nozzles keep their shape unchanged for years, when compared with plastic solutions on the market, and ensure brilliant, long-lasting results. Their stainless steel filter provides efficient water filtration and better pump protection, because it is not worn away by hot water and detergent.

Bracci di lavaggio in acciaio inox.

A differenza delle soluzioni in plastica proposte dai concorrenti, mantengono inalterata la forma dei getti "a lama" anche a distanza di anni, per un perfetto risultato di lavaggio. Il filtro in acciaio inox non viene eroso dall'acqua calda e dal detersivo, per un'efficacia di filtrazione costante nel tempo e una miglior protezione della pompa.

Bras de lavage en acier inox.

La forme de jets "à lame" reste inchangée même après beaucoup d'années d'utilisation, tandis que les solutions en plastiques déjà proposées dans le marché sont moins fiables. Le filtre en acier inox n'est pas détérioré par l'eau chaude et le détergent, qui garantit une constante filtration efficace et une meilleure protection de la pompe.

Classy interface with chromed buttons. Led lamps are more visible than standard to better control the machine also from far away.

Elegante interfaccia con pulsanti cromati. Le spie a led, più luminose di quelle tradizionali, permettono di controllare lo stato della macchina anche da distante.

Interface élégante avec des boutons chromés. Les voyants LED, plus lumineuses que les lampes traditionnelles, vous permettent de vérifier l'état de l'appareil, à distance aussi.



value line



AF 56



AF 56

Eco friendly: -40% of water*

The "technological core" of model AF 56 is represented by its double water filtration system, which helps you to keep water cleaner. This means that 40% less[°] water is needed in the washing tank for remarkable energy and detergent savings.

Eco friendly: - 40% di acqua*

Il "cuore tecnologico" della AF56 sta nel doppio sistema di filtrazione, che permette di mantenere l'acqua più pulita. Il suo vantaggio principale è il minor utilizzo di acqua in vasca, ben il 40% in meno[°], con un sensibile risparmio di energia e detersivo.

Eco friendly: 40% moins d'eau*

Le centre technologique du modèle AF56 est dans le système de double filtration, qui maintient l'eau propre. L'avantage le plus important est la réduction d'eau dans la cuve de lavage, le 40% en moins[°], avec des économies considérables d'énergie et de détergent.

[°]As compared with the model B 31 / Rispetto al modello B31 / Par rapport au modèle B31



AF 56



AF 56

Rounded washing tank edges prevent dirt from being stuck in corners. You will experience quicker cleaning operations and a better smelling dishwasher.

I bordi raggiati della vasca impediscono allo sporco di rimanere intrappolato negli spigoli. La pulizia sarà più veloce e si eviteranno i cattivi odori.

Les bords arrondis de la cuve empêchent que la saleté reste dans les coins. Le nettoyage sera plus rapide et les odeurs désagréables seront évitées.

Only 2.5 Lt. of water required for each washing cycle for best-in-class energy savings.

Solo 2,5 Lt di consumo d'acqua per ciclo di lavaggio. Risparmio energetico ai vertici della categoria.

Consommation de 2,5 Lt seulement d'eau par cycle de lavage. Les économies d'énergie les plus hautes dans la catégorie.



performance line



AF 521 – 521 D*



AF 521

Best wash

Performance line stands as the more matching the needs of those Chefs looking for the best washing performance. Brilliant washing results thanks to its 8 cycles: it is possible to optimize the washing performances according to the type of crockery.

Il miglior lavaggio

Performance line è la più indicata per gli Chef che ricercano la migliore performance di lavaggio. Gli 8 cicli disponibili permettono di ottimizzare le prestazioni di lavaggio in base al tipo di stoviglie, per un risultato sempre impeccabile.

Le meilleur lavage

La série Performance Line est la plus appropriée pour les chefs qui recherchent les meilleures performances de lavage. Les 8 cycles disponibles vous permettent d'optimiser le lavage en fonction du type de vaisselle, pour un résultat toujours impeccable.



AF 521
AF 521 D*



AF 521



PRP – Perfect Rinse Performance

Available on demand, PRP – Perfect Rinse Performance – ensures water temperature at 82°C during the complete rinsing cycle. It represents a surefire solution for absolute dishes sanitization and quick, efficient drying.

PRP – Perfect Rinse Performance è la tecnologia (optional) che mantiene la temperatura ad 82°C per tutto il ciclo di risciacquo. Una garanzia di sanitizzazione delle stoviglie e di tempi di asciugatura ridotti.

PRP – Perfect Rinse Performance est la technologie (en option), qui maintient la température à 82 °C tout au long du cycle de rinçage. Une garantie de parfaites performances de rinçage avec des temps de séchage réduits et une hygiénisation de la vaisselle.

Highly resistant and anti-scratch capacitive display, designed to bear with any modern kitchens stress.

Display capacitivo antigraffio e resistente agli urti, studiato per resistere all'utilizzo frenetico delle cucine professionali.

Affichage résistant aux rayures et aux chocs, conçu pour résister à l'utilisation frénétique des appareils professionnels



performance line



AF 611 – 781



AF 781

Premium finishing

Our dishwashers featuring the most refined design, well identified by their touch screen display and rounded and smooth internal shape.

A double-skinned, insulated washing tank (model AF 7801 only) increases your comfort, thanks to lower noise and remarkable energy savings.

Design di gran classe

Lavastoviglie dal design più ricercato, con il display touch-screen e le superfici interne arrotondate ed eleganti.

La vasca in doppia parete con isolamento (solo modello AF781) aumenta il confort dell'operatore riducendo la rumorosità, e migliora ulteriormente i consumi energetici.

Design premium

Lave-vaisselles avec le design le plus sophistiqué, avec un affichage tactile et des surfaces internes arrondies et élégantes. La cuve à double paroi avec isolation (modèle AF781 seulement) augmente le confort de l'opérateur en réduisant le bruit et améliore encore la consommation d'énergie.



AF 611

AF 781



AF 781



Double water filtration system with stainless steel filters helps you in keeping water cleaner for longer. 20% less* water in the washing tank means energy and detergent savings.

Il doppio sistema di filtraggio in acciaio inox, permette di mantenere l'acqua più pulita e più a lungo. La presenza del 20% di acqua in meno in vasca* permette di risparmiare energia e detersivo.

Le double système de filtration en acier inox permet de garder l'eau propre à long terme. Le 20% moins d'eau dans la cuve* permet d'économiser de l'énergie et de détergent.

HD Full-touch display with colored icons, the most intuitive and easy to use.

Il Full-Touch display in HD ad icone colorate è intuitivo e più facile da usare.

L'affichage Full-Touch HD avec icônes colorées est intuitif et facile à utiliser.



*As compared with the model AF 56 / rispetto al modello AF56 / Par rapport au modèle AF56.

performance line



AF 881



AF 881

Wash Euronorm trays!

AF 881 is extremely versatile: thanks to its high door opening of 40 cm, 15% more powerful pump and 30% more powerful heating element*, it can wash even Euronorm trays.

Anche per vassoi Euronorm!

Il modello AF 881 è caratterizzato da una grande versatilità nell' utilizzo. Può lavare persino vassoi di dimensione Euronorm, grazie alla maggiore luce porta di 40cm, ad una pompa più potente del 15% ed a un 30% in più di potenza riscaldante*.

Pour plateaux Euronorm aussi!

Le modèle AF 881 est caractérisé par une grande versatilité. Il est possible aussi laver les plateaux Euronorm, grâce à une plus grande hauteur utile, soit 40 cm, à une pompe plus puissante de 15% et une puissance de 30% de plus de chauffage*.



AF 881



AF 881

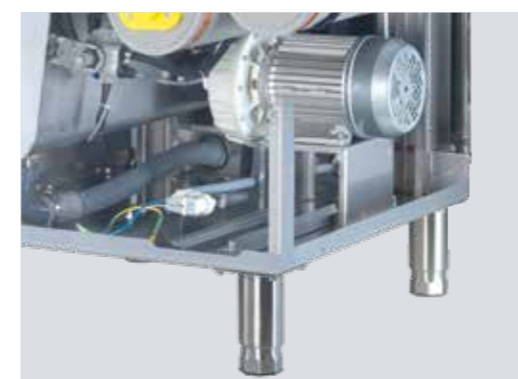

Double-skinned, insulated washing tank increases your comfort, thanks to lower noise and remarkable energy savings.

Vasca in doppia parete con isolamento, che aumenta il comfort dell'operatore riducendo la rumorosità, e migliora ulteriormente i consumi energetici.

Cuve avec double isolation des parois, ce qui augmente le confort de l'opérateur en réduisant le bruit et améliore la consommation d'énergie.



Maximum ergonomics! The increased working height at 1.2 mt means that loading and unloading baskets is easier.

Più ergonomica! L'altezza maggiorata ad 1,2mt facilita il caricamento e scaricamento cesti.

Plus ergonomique ! La hauteur utile à 1,2 mt facilite le chargement et déchargement des paniers.

*As compared with the model AF 56 / Rispetto al modello AF 56 / Par rapport au modèle AF 56

	 mm	 mm	 mm	 mm	 Volt/Hz	kW	 Program	
 B31	a 600 b 600 h 820	500 x 500	290	330	230 V ~ 1 230 V ~ 3 400 V ~ 3N 50 Hz	3,5	1	540
 B31 D	a 600 b 600 h 820	500 x 500	290	330	230 V ~ 1 230 V ~ 3 400 V ~ 3N 50 Hz	3,5	1	540
 AF56	a 600 b 600 h 850	500 x 500	305	350	230 V ~ 1 230 V ~ 3 400 V ~ 3N 50 Hz	3,5	1	540
 AF521	a 600 b 600 h 850	500 x 500	290	330	230 V ~ 1 230 V ~ 3 400 V ~ 3N 50 Hz	3,5	8	1080 max 108 min

	 mm	 mm	 mm	 mm	 Volt/Hz	kW	 Program	
 AF521D	a 600 b 600 h 850	500 x 500	290	330	230 V ~ 1 230 V ~ 3 400 V ~ 3N 50 Hz	3,5	8	1080 max 108 min
 AF611	a 600 b 600 h 850	500 x 500	300	350	230 V ~ 1 230 V ~ 3 400 V ~ 3N 50 Hz	5	8	1080 max 108 min
 AF781	a 600 b 600 h 850	500 x 500	300	350	230 V ~ 1 230 V ~ 3 400 V ~ 3N 50 Hz	6,5	8	1080 max 108 min
 AF881	a 635 b 600 h 1275	500 x 500	385	405	230 V ~ 3 400 V ~ 3N 50 Hz	6,8	8	1080 max 108 min



professional dishwashers

ATA srl

Viale del Progresso, 20 - ZI
35026 Conselve (Padova) - Italy
Tel. +39 049 9500555
Fax. +39 049 9500560
mail@atasrl.com
www.atasrl.com





Lavavajillas frontales

Посудомоечные машины с фронтальной загрузкой /
Untertischspülmaschinen



Hazlo posible con ATA connect

Imagina que el técnico mismo entre en tu restaurante y te pida de poder revisar el lavavajillas, en lugar de tener que llamarlo.

Imagina que el técnico conozca el problema de tu lavavajillas incluso antes de verlo y que pueda repararlo rápidamente, ya teniendo el repuesto correcto. Ahora es posible con nuestros lavavajillas WiFi.

Сделайте это возможным при помощи ATA connect.

Представьте себе, что техник-специалист входит в ваш ресторан и просит разрешения проверить вашу посудомоечную машину, и вам даже не пришлось его вызывать. Представьте себе, что техник-специалист знает, что именно неисправно в вашей посудомоечной машине, ещё до того, как увидит саму машину, он сможет быстро её наладить, и у него всегда найдётся подходящая запчасть. Теперь это стало возможным с нашими посудомоечными машинами с WiFi.

Machen Sie es möglich mit ATA Connect.

Stellen Sie sich vor, der Techniker betritt Ihr Restaurant und bittet Sie, den Geschirrspüler zu überprüfen, anstatt dass Sie ihn anrufen müssen. Stellen Sie sich vor, der Techniker kennt das Problem Ihres Geschirrspülers, schon bevor er sie sich angesehen hat, und er kann sie schnell reparieren, wobei er immer das richtige Ersatzteil dabei hat. Das ist jetzt mit unseren WLAN-Geschirrspülmaschinen möglich.

Las nuevas funcionalidades a tu servicio /
Новая функциональность - к вашим услугам /
Neue Funktionen zu Ihren Diensten



Control remoto

Siempre conectado a tu centro de asistencia, para que te sientas cómodo.

Удалённая проверка

Постоянно на связи с вашим Центром технической помощи, ради вашего спокойствия.

Steuerung über Fernbedienung

Immer mit Ihrem Kundendienstzentrum verbunden, damit Sie sich um nichts sorgen müssen



Mantenimiento preventivo

Informes de mantenimiento periódico, para evitar paradas de la máquina.

Профилактическое техобслуживание

Сообщения о периодическом техобслуживании, чтобы избежать простоев оборудования.

Vorbeugende Wartung

Berichterstattung über regelmäßige Wartungen, um Maschinenstillstände zu vermeiden.



Envío de mensajes de error

Comunicación de problemas vía WiFi, para un mantenimiento más rápido.

Отправка сообщений об ошибке

Передача информации о неисправности через WiFi, для более быстрого ремонта

Senden von Fehlermeldungen

Kommunikation von Problemen über WLAN für eine schnellere Wartung.



Programación de ciclos remotos

Cambio de parámetros de lavado más rápido y más barato.

Удалённое программирование циклов мойки

Изменение параметров для более быстрой и экономичной мойки.

Remote-Zyklusprogrammierung

Schnellere und wirtschaftlichere Änderungen der Spülparameter.

ATA connect

Disfrutes del mejor servicio de asistencia técnica del mercado con ATA Connect, el sistema que combina la tecnología de transmisión de datos WiFi con un código QR de asistencia. Tu técnico puede monitorear el lavavajillas a distancia y la máquina le envía señales de error, a veces incluso antes de que hayas notado el problema.

También aconseja al técnico cuándo realizar el mantenimiento preventivo, para que pueda programarse cuando el local no esté abierto al público y evitar tiempos de inactividad durante el servicio.

¿No está satisfecho con los 8 ciclos de lavado preestablecidos? ¿El lavavajillas ya no lava bien después de cambiar la marca de detergente? No te preocupes: tu técnico podrá cambiar los parámetros del ciclo de forma remota y rápida.

Finalmente, puedes concentrarte en lo que más amas hacer: cuidar de tus clientes.

Наслаждайтесь наилучшей на рынке Службой технической помощи ATA Connect, которая сочетает WiFi технологию передачи данных со службой QR-кода. Посудомоечная машина удалённо отслеживается вашим техником-специалистом, машина сама отправляет технику сообщения при возникновении ошибок, иногда даже раньше, чем вы заметили проблему.

Кроме того, машина подсказывает технику, когда требуется провести профилактическое техобслуживание, чтобы спланировать его на то время, когда заведение закрыто для публики и избежать простоев машины во время работы.

Вы не удовлетворены 8-ю предустановленными моечными циклами? Посудомоечная машина перестала хорошо мыть после смены марки моющего средства? Не беспокойтесь: ваш техник в кратчайшее время сможет удалённо изменить параметры цикла.

Наконец-то вы сможете сосредоточиться на том, чем вам больше нравится заниматься: обслуживанием ваших клиентов.

Mit ATA Connect, dem System, das die WLAN-Datenübertragungstechnologie mit einem Service-QR-Code kombiniert, können Sie den besten technischen Support auf dem Markt genießen. Der Geschirrspüler wird von Ihrem Techniker fernüberwacht und sendet die Fehlermeldungen manchmal sogar noch bevor Sie das Problem bemerkt haben.

Sie weist den Techniker auch darauf hin, wenn vorbeugende Wartungsarbeiten anstehen, damit diese programmiert werden können, wenn das Lokal nicht für die Öffentlichkeit zugänglich ist, und um Ausfallzeiten der Maschine während der Wartung zu vermeiden.

Genügen Ihnen die 8 voreingestellten Spülzyklen nicht? Spült der Geschirrspüler nach einem Wechsel der Spülmittelmarke nicht mehr richtig? Keine Sorge: Ihr Techniker kann die Zyklusparameter aus der Ferne schnell ändern.

Endlich können Sie sich auf das konzentrieren, was Sie am liebsten tun: sich um Ihre Gäste kümmern.



Video disponible en www.atasrl.com
Видео доступно на сайте: www.atasrl.com
Video auf www.atasrl.com verfügbar

ATA advantages

Auto-clean

Un ciclo de autolimpieza reduce el tiempo y el costo de la limpieza del lavavajillas.

Цикл самоочистки позволяет сократить время и стоимость чистки посудомоечной машины.

Ein Selbstreinigungszyklus reduziert die Zeit und die Kosten für die Reinigung des Geschirrspülers.

Water softener

Nuestro ablandador de agua de última generación (modelos con D) regenera las resinas durante el ciclo de lavado, sin tiempo de inactividad de la máquina.

Наш умягчитель воды (модели с литерой D) последнего поколения восстанавливает смолы во время цикла мойки, без простоев машины.

Unser Wasserenthärter der neuesten Generation (Modelle mit D) regeneriert die Harze während des Waschzyklus ohne Maschinenausfallzeiten.

Thermolock System

Asegura la perfecta higienización de los vasos, gracias a que el ciclo de enjuague solo se hace con agua a 82°C.

Thermolock - это система, обеспечивающая санитарную обработку посуды, поскольку позволяет ополаскивать её лишь водой температурой не ниже 82°C.

Thermolock ist das System, das die Desinfektion von Geschirr garantiert, da es das Nachspülen nur mit 82° C heißem Wasser zulässt.

Smart Dispenser

Sistema de dosificación inteligente del detergente (opcional), detecta la cantidad de suciedad y dispensa la dosis justa de detergente.

Система "умного" дозирования моющего средства (опция), которая "чувствует" грязь и выдаёт строго необходимое количество моющего средства.

Intelligentes Dosiersystem für das Geschirrspülmittel (optional), das den Schmutz „fühlt“ und nur die benötigte Menge ausgibt.



Plates

El ciclo más versátil para diferentes tipos de suciedad, como grasas, proteínas o almidones.

Наиболее гибкий цикл для загрязнений различного типа, таких, как жир, белок или крахмал.

Der vielseitigste Spülgang für verschiedene Schmutzarten wie Fette, Proteine oder Stärken.

Glasses

Vasos secos y brillantes con un ciclo de lavado corto combinado con un enjuague suave.

Сухие и блестящие стаканы с коротким циклом мойки, в сочетании с нежным ополаскиванием.

Trockene und glänzende Gläser mit einem kurzen Waschgang, kombiniert mit sanftem Abspülen.

Cutlery

Los cubiertos se pueden lavar a altas temperaturas para eliminar mejor la suciedad sin deteriorarlos.

Столовые приборы можно мыть при высокой температуре, чтобы лучше удалить загрязнения, без повреждения приборов.

Besteck kann bei hohen Temperaturen gewaschen werden, um Schmutz gründlich zu entfernen, ohne es zu beschädigen.

Sanitization

Un mayor tiempo de lavado, a temperaturas más altas, para desinfectar la vajilla.

Большее время мойки, при более высокой температуре, для санитарной обработки посуды.

Eine längere Waschzeit bei höheren Temperaturen, um das Geschirr zu desinfizieren.

Pots

Un ciclo más largo para objetos muy sucios e incrustados.

Наиболее долгий цикл для очень грязных предметов с накипью (коркой).

Ein längerer Zyklus für stark verschmutzte und verkrustete Utensilien.

Fragile glasses

La función soft-start evita roturas a los flutes.

Функция мягкого старта позволяет избежать раскола фужеров.

Die Softstart-Funktion vermeidet Brüche von empfindlichen Sektgläsern.

Custom

Eliges tu las temperaturas y tiempos de lavado.

Вы сами выбираете температуру и время мойки. Wählen Sie selbst die Temperaturen und Waschzeiten.

Eco clean

Ciclo de ahorro de energía. Ciclo с экономией энергии. Energiesparzyklus.

ATA technology

Service QR code

El código QR de Asistencia proporciona a nuestros socios técnicos toda la información necesaria para una instalación correcta, como el Manual y los diagramas de conexión. Cada centro de asistencia autorizado por ATA puede acceder a la lista de repuestos del lavavajillas. De este modo, puede identificar rápidamente el componente a reemplazar y solicitarlo en tiempo real desde el teléfono, sin errores y en solo 3 simples pasos.

Служба QR-кода даёт нашим партнёрам – техникам всю информацию, необходимую для правильной установки оборудования, т.е. Руководства и Схемы подключения. Каждый Авторизованный сервисный центр фирмы ATA может получить доступ к списку запчастей посудомоечной машины. Таким образом, Сервисный центр может быстро определить часть, требующую замены, и заказать её в реальном времени с сотового телефона, безошибочно и всего лишь за 3 простых шага.

Mit dem Service-QR-Code erhalten unsere technischen Partner alle Informationen, die für eine ordnungsgemäße Installation erforderlich sind, z. B. das Handbuch und die Anschlusspläne. Jedes zugelassene ATA-Service-Center kann auf die Ersatzteilliste für Geschirrspüler zugreifen. So kann es die auszutauschende Komponente schnell identifizieren und in Echtzeit fehlerfrei und in nur 3 einfachen Schritten über das Telefon bestellen.

step 1

Veas el código QR con la cámara del teléfono, para ser redirigido automáticamente a nuestro sitio web.

Навести на QR-код камеру сотового телефона, автоматически произойдёт перенаправление на наш интернет-сайт.

Erfassen Sie den QR-Code mit der Kamera des Telefons, um automatisch auf unsere Website umgeleitet zu werden.

step 2

Abras la lista de piezas del lavavajillas y seleccione las que desea reemplazar.

Открыть список запчастей посудомоечной машины и выбрать части, требующие замены.

Öffnen Sie die Liste der Ersatzteile für Geschirrspüler und wählen Sie die Teile aus, die ausgetauscht werden sollen.

step 3

Agregue los repuesto al carrito de compras y envíe el pedido con un simple clic.

Добавить запчасти в корзину и отправить заказ одним кликом.

Legen Sie die Ersatzteile in den Warenkorb und senden Sie die Bestellung mit einem einfachen Klick ab.



Video disponible en www.atasrl.com
Видео доступно на сайте: www.atasrl.com
Video auf www.atasrl.com verfügbar



step 1



step 2



step 3



basic line



Robustez y fiabilidad

Resistencia y fiabilidad sin compromiso, garantizadas por los estándares de producción ATA. Soluciones técnicas diseñadas para maximizar la facilidad de uso y reducir los costos de gestión y mantenimiento.

Прочность и надёжность

Бескомпромиссная прочность и надёжность, гарантированные стандартом производства компании ATA. Технические решения, разработанные для максимального упрощения использования и снижения стоимости управления и обслуживания.

Robust und zuverlässig

Robust und zuverlässig ohne Kompromisse, garantiert durch ATA-Produktionsstandards. Technische Lösungen zur Maximierung der Benutzerfreundlichkeit und Reduzierung der Kosten für Verwaltung und Wartung.

value line



Rendimiento y acabados refinados

Diseñada para quien busca una oferta ventajosa combinada con la más alta calidad, la línea Value es un concentrado de tecnologías destinadas a reducir el consumo energético, a mejorar la eficiencia del sistema de filtración y a acelerar las operaciones de limpieza.

Изысканное исполнение и отделка

Эта линия создана для тех, кто ищет выгодное предложение в сочетании с максимальным качеством, Value line - это средоточие технологий, нацеленных на снижение потребления энергии, улучшение эффективности системы фильтрации и ускорение операций по чистке.

Hochwertige Leistungen und Oberflächen raffiniées

Die Value-Linie wurde für Kunden entwickelt, die ein vorteilhaftes Angebot in Verbindung mit maximaler Qualität suchen. Sie ist ein Konzentrat von Technologien, die darauf abzielen, den Energieverbrauch zu senken, die Effizienz des Filtersystems zu verbessern und die Reinigungsvorgänge zu beschleunigen.

performance line



Excelencia en lavado

Performance es la línea que representa la excelencia en el rendimiento de lavado. Lo mejor contra todo tipo de suciedad persistente, gracias a las potencias elevadas y a la posibilidad de personalizar los ciclos de lavado según el tipo de suciedad.

Превосходная мойка

Performance - это линия, обеспечивающая превосходную степень качества мойки. Самая лучшая очистка любых трудноудаляемых загрязнений благодаря высокой мощности и возможности персонализировать циклы мойки в зависимости от типа загрязнения.

Exzellente Spülqualität

Performance ist die Linie, die für hervorragende Spülleistung steht. Das Beste gegen alle Arten von hartnäckigem Schmutz, dank der hohen Leistungsfähigkeiten und der Möglichkeit, die Spülzyklen individuell anzupassen.

El lavavajillas ideal para todos los Chefs

Идеальная посудомоечная машина для каждого шеф-повара

Die ideale Gläserspülmaschine für alle Meisterköche

basic line



B 31 – 31D*



B 31

100% acero inox

Máxima simplicidad de uso: con un solo botón de control (además del botón de ENCENDIDO / APAGADO), el lavavasos es fácil de usar incluso para operadores sin experiencia. Una solución perfecta para locales con alta rotación de personal.

100% нержавеющей сталь

Максимальная простота использования: управление при помощи одной кнопки (помимо кнопки ВКЛ/ВЫКЛ) - посудомоечной машиной просто пользоваться даже неопытным операторам. Идеальное решение для заведений с высокой ротацией персонала.

100 % rostfreier Edelstahl

Höchster Bedienkomfort: Mit nur einer Bedientaste (zusätzlich zur EIN-AUS-Taste) ist die Gläserspülmaschine auch für unerfahrene Personen einfach zu bedienen. Eine perfekte Lösung für Lokale mit hoher Mitarbeiter-Rotation.

B 31
B 31 D*

B 31



Brazos de lavado en acero inoxidable. A diferencia de las soluciones plásticas que ofrece el mercado, mantienen sin alteraciones la forma de "cuchillo" de los chorros, incluso años más tarde, para un resultado de lavado perfecto. El filtro de acero inoxidable no es erosionado por el agua caliente y el detergente, para una eficiencia de filtrado constante y una mejor protección de la bomba.

Моечные рукава из нержавеющей стали. В отличие от пластмассовых решений, представленных на рынке, они сохраняют неизменной форму "ножевых" струй даже спустя много лет, для достижения идеального результата мойки. Фильтр из нержавеющей стали не корродирует от горячей воды и моющего средства, обеспечивая эффективную фильтрацию, неизменную с течением времени, и лучшую защиту насоса.

Sprüharme aus rostfreiem Edelstahl. Im Gegensatz zu den auf dem Markt angebotenen Kunststoff-Sprühdüsen bleiben die „klingenförmigen“ Düsen über lange Jahre unverändert und es wird immer ein perfektes Spülergebnis erzielt. Der Edelstahlfilter wird durch heißes Wasser und Reinigungsmittel nicht angegriffen und somit ist eine konstante Filtrationseffizienz und ein besserer Schutz der Pumpe gewährleistet.

Interfaz elegante con botones cromados. Las luces LED, más brillantes que las tradicionales, permiten verificar el estado de la máquina incluso a distancia.

Еlegantный интерфейс с хромированными кнопками. Светодиодные контрольные лампы, более яркие, чем традиционные, позволяют контролировать состояние машины даже на расстоянии.

Elegante Benutzeroberfläche mit Chromknöpfen. Mit LED-Leuchten, die heller als herkömmliche Leuchten sind, können Sie den Status des Geräts auch aus der Ferne überprüfen.



value line



AF 56



AF 56

Solución ecológica: -40% de agua*

El "corazón tecnológico" del AF56 se encuentra en el sistema de doble filtración, que permite mantener el agua más limpia. Su principal ventaja es el menor uso de agua en la cuba, bien un 40% menos*, con un ahorro significativo de energía y detergente.

Экологичность: -40% воды*

Технологическое "ядро" этой модели заключается в двойной системе фильтрации, позволяющей сохранять воду более чистой. Её основное преимущество - меньшее использование воды в ванне, на целых 40% меньше*, с ощутимой экономией энергии и моющего средства.

Umweltfreundlich: -40% Wasser

Das "technologische Herz" des AT901 ist im Filtersystem, das doppelt ist und das Wasser sauber hält. Sein Hauptvorteil ist der um bis zu 40% geringere Wasserverbrauch im Tank* bei einer deutlichen Einsparung von Energie und Reinigungsmittel.

*comparado con el modelo B 31 / относительно модели B31 / im Vergleich zum Modell B31



AF 56



AF 56

Los bordes redondeados de la cuba evitan que la suciedad quede atrapada en las esquinas. La limpieza será más rápida y se evitarán los olores.

Закруглённые края ванны не позволяют грязи скапливаться в углах. Чистка будет быстрее, отсутствие плохого запаха.

Die abgerundeten Kanten des Spülbeckens verhindern, dass Schmutz in den Ecken bleibt. Die Reinigung erfolgt schneller und Gerüche werden vermieden.

Solo 2,5 Lt de consumo de agua por ciclo de lavado. Ahorro de energía a la cima de su categoría.

Менее 2,5 литров расхода воды на цикл мойки. Максимальная экономия энергии для данной категории.

Nur 2,5 Liter Wasserverbrauch pro Spülgang. Energieeinsparung an der Spitze der Kategorie.



performance line



AF 521 – 521D*



AF 521

El mejor lavado

La línea Performance es la más adecuada para los Chefs que buscan el mejor rendimiento de lavado. Los 8 ciclos disponibles permiten optimizar el rendimiento de lavado según el tipo de vajilla, para un resultado siempre impecable.

Наилучшая мойка

Серия посудомоечных машин Performance line наиболее показана для шеф-поваров, которые стремятся к наилучшему качеству мойки. 8 предустановленных циклов позволяют оптимизировать параметры мойки в зависимости от типа посуды, для достижения всегда безупречного результата.

Beste Spülleistung

Die Performance Line ist für Meisterköcher geeignet, für die beste Waschleistung das Wichtigste ist. Mit den 8 verfügbaren Zyklen können Sie die Spülleistung je nach Geschirrtyp optimieren, um stets ein einwandfreies Ergebnis zu erzielen.

AF 521
AF 521 D*

AF 521



PRP - Perfect Rinse Performance

PRP - Perfect Rinse Performance - es la tecnología (opcional) que mantiene la temperatura a 82 °C durante todo el ciclo de enjuague. Una garantía de saneamiento de las vajillas y de tiempos reducidos de secado.

PRP - Perfect Rinse Performance – это технология (опция), поддерживающая температуру на 82°C в течение всего цикла ополаскивания. Это обеспечивает санитарную обработку посуды и сокращённое время сушки.

PRP - Perfect Rinse Performance - ist die Technologie (optional), die die Temperatur während des gesamten Spülzyklus auf 82 °C hält. Eine Garantie für die Desinfektion des Geschirrs und verkürzte Trocknungszeiten.

Pantalla capacitiva resistente a los arañazos y a los impactos, diseñada para resistir el uso frenético de las cocinas profesionales.

Ёмкостный царапиноустойчивый и ударопрочный дисплей разработан специально для использования в "лихорадочной" атмосфере профессиональной кухни.

Kratzfeste und schlagfeste Kapazitätsanzeige, die dem hektischen Einsatz gewerblicher Küchen standhält.



performance line



AF 611 – 781



AF 781

Diseño elegante

Lavavajillas de diseño más sofisticado, con pantalla táctil y superficies internas redondeadas y elegantes. La cuba de doble pared con aislamiento (solo model AF 781) aumenta la comodidad del operador, al reducir el ruido, y mejora aún más los consumos de energía.

Высококласный дизайн

Посудомоечные машины самого изысканного дизайна, с сенсорным дисплеем и элегантными закруглёнными внутренними поверхностями. Ванна с двойной стенкой с теплошумоизоляцией (только модель AF781) увеличивает комфорт оператора, снижая шум, и даёт ещё большую экономию энергии.

Ganz besonders edles Design

Hochwertigste Design-Geschirrspüler mit Touchscreen-Display und abgerundeten und eleganten Innenflächen. Der doppelwandige Tank mit Isolierung (Modell AF781 nur) erhöht den Bedienkomfort durch Geräuschreduzierung und verbessert den Energieverbrauch weiter.



AF 611

AF 781



AF 781



El doble sistema de filtrado en acero inoxidable permite mantener el agua más limpia y por más tiempo. La presencia de un 20% menos de agua en la cuba* permite de ahorrar energía y detergente.

Двойная система фильтрации из нержавеющей стали позволяет поддерживать воду более чистой в течение более долгого времени. Количество воды в ванне, уменьшенное на 20%, позволяет экономить энергию и моющее средство.

Das doppelte Filtersystem aus Edelstahl ermöglicht es Ihnen, das Wasser länger sauber zu halten. 20% weniger Wasser im Tank* spart Energie und Spülmittel.

La pantalla Full-Touch HD con iconos de colores es intuitiva y más fácil de usar.

Полностью сенсорный HD дисплей с цветными пиктограммами - интуитивный и более простой в использовании.

Das Full-Touch HD-Display mit farbigen Symbolen ist intuitiv und einfacher zu bedienen.



*comparado con el modelo AF 56 / относительно модели AF56 / im Vergleich zum Modell AF56.

performance line



AF 881



AF 881

También para bandejas Euronorm!

El modelo AF 881 se caracteriza por una gran versatilidad de uso. Puede lavar incluso bandejas de tamaño Euronorm, gracias a su altura puerta de 40 cm, una bomba más potente del 15% y un 30% más de potencia de calentamiento*.

Также для подносов Euronorm!

Модель AF 881 отличается большой гибкостью в использовании. Машина способна мыть даже подносы размеров Euronorm благодаря увеличенному до 40 см проёму дверцы, более мощному на 15% насосу и увеличенной на 30% мощности нагрева*.

Geeignet für Euronorm-Tabletts auch!

Das Modell AF 881 zeichnet sich durch große Einsatzvielfalt aus. Dank der zusätzlichen 40-cm-Türhöhung, einer um 15% stärkeren Pumpe und 30% höherer Heizleistung* können sogar Tabletts im Euronorm-Format gespült werden.



AF 881



AF 881



Cuba de doble pared con aislamiento, que aumenta la comodidad del operador al reducir el ruido y mejora aún más el consumo de energía.

Ванна с двойной стенкой с теплошумоизоляцией увеличивает комфорт оператора, снижая шум, и даёт ещё большую экономию энергии.

Doppelwandiger Tank mit Isolierung, der den Bedienerkomfort erhöht, indem er Geräusche reduziert und den Energieverbrauch weiter verbessert.



¡Más ergonómico! La altura aumentada de 1,2 m facilita las operaciones de carga y descarga de cestas.

Более эргономична! Увеличенная до 1,2 м высота облегчает загрузку и разгрузку корзин.

Ergonomischer! Die Höhe wurde auf 1,2 m erhöht, was das Be- und Entladen von Körben erleichtert.



ATA srl

Viale del Progresso, 20 - ZI
35026 Conselve (Padova) - Italy
Tel. +39 049 9500555
Fax. +39 049 9500560
mail@atasrl.com
www.atasrl.com





Ware washers

Lavaoggetti - Lave-ustensils



ATA Warewasher

The right ware washer for every need

Backing trays, baskets, pots, pans, ladles, cake moulds and bowls are just a few items – different in shape and dimensions – to be washed in patisseries, ice-cream parlours, bakeries, butcher's shops, restaurants and canteen kitchens. No matter what kind of user you are, you can easily find the model that best matches your needs within ATA ware washers range ALP.





Per ogni oggetto la giusta soluzione di lavaggio

Teglie, ceste, pentole, mestoli, forme da dolci e bacinelle: tanti e di varie forme e dimensioni sono gli oggetti da lavare nei laboratori di pasticceria e gelateria, nei panifici e macellerie, nelle cucine dei ristoranti e nelle mense.

Che si tratti di piccole o grandi utenze, ciascuna può trovare all'interno della gamma di lavaoggetti ALP fabbricate da ATA il suo modello ideale.

Pour chaque ustensile la solution de lavage la plus appropriée

Des plaques, des casiers, des casseroles, des louches, des moules à gâteau et des cuvettes : les formes et les dimensions des ustensiles de cuisine à laver chez les pâtisseries et les glaciers, chez les boulangers et les bouchers et dans les cuisines des restaurants et cantines sont nombreuses et variées. Les petits ou les grands laboratoires peuvent tous trouver leur modèle idéal dans la gamme de lave-batteries ALP fabriqués par ATA.



A SIMPLE BUT SMART HEART

A soft-touch interface enables you to adapt the wash cycle parameters to the different needs.

UN CUORE SEMPLICE E INTELLIGENTE

Un'innovativa logica soft-touch permette di personalizzare i parametri di lavaggio in funzione degli oggetti da lavare.

UN CŒUR SIMPLE ET INTELLIGENT

Une interface à touches sensibles permet d'adapter le cycle de lavage aux ustensiles à laver.



A STURDY, BALANCED BODY

The body, the wash arms and the filters are made of stainless steel to ensure the best functionality in professional services.

UN CORPO FORTE E BILANCIATO

La struttura, i bracci di lavaggio e i filtri sono in acciaio inox per la massima durata nell'impiego professionale.

UNE STRUCTURE FORTE ET ÉQUILBRÉE

La structure, les bras de lavage et les filtres sont en acier inox. La meilleure performance pour l'usage professionnel.



WHAT IS NEEDED WHEN IT IS NEEDED

The ATA's Smart Dispenser is an intelligent dosing system (optional) that "feels" the dirt and pours only the needed detergent. This makes this range even more economical in use.

QUANDO SERVE & QUANTO SERVE

Ancora più economica nella gestione se abbinata allo Smart Dispenser ATA, il sistema di dosaggio intelligente del detersivo (optional), che "sente" lo sporco e ne immette solo la quantità necessaria.

COMBIEN ÇA COÛTE & QUAND L'UTILISER

Encore plus économique à l'usage si l'appareil est combiné avec le Smart Dispenser ATA, le système de dosage intelligent de détergent (option), que «capte» la saleté et ne diffuse que la quantité requise.

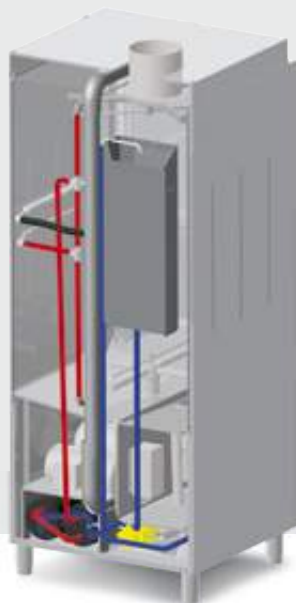

BEST WASHING PERFORMANCE

Excellent rinsing results thanks to the W.A.G.P. A built-in water reserve with pump ensures constant water pressure and capacity, no matter what the inlet water pressure may be.

RISULTATI ECCELLENTI

Risciacquo perfetto con W.A.G.P.: il sistema che, con una vasca ed una pompa addizionali, fornisce la giusta pressione e portata d'acqua indipendentemente dai valori di rete.

RÉSULTATS IMPECCABLES

Le système W.A.G.P. permet d'obtenir d'excellents résultats de rinçage par un réservoir d'eau incorporé qui grâce à une pompe assure une pression et un débit constant indépendamment de la pression d'alimentation.



HYGIENE GUARANTEED

An additional boiler keeps the temperature above 80°C during the entire rinse cycle, to reduce the bacterial load.

IGIENE GARANTITA

Un boiler aggiuntivo mantiene la temperatura sopra gli 80°C durante tutto il ciclo di risciacquo, a garanzia della rimozione della carica batterica.

HYGIÈNE GARANTIE

Un surchauffeur supplémentaire maintient la température au-dessus de 80°C pendant tout le cycle de rinçage, afin de garantir l'élimination de bactéries.

ALP 40

Ideal for trays in pastry shops 60x40 cm

Ideale per teglie da pasticceria 60x40 cm
Idéal pour plateaux de pâtisserie 60x40 cm



Thanks to its compact dimensions the model ALP 40 is the perfect solution for **patisseries, ice cream parlours and pizzerias**. It allows you to **wash up to 4 trays at the same time**.

Il modello ALP 40, con le sue dimensioni molto compatte, si adatta in modo eccellente ai piccoli laboratori di pasticceria, gelaterie e pizzerie. Permette di lavare fino a 4 teglie da pasticceria contemporaneamente.

Le modèle ALP 40, avec ses dimensions compactes, s'adapte très bien aux **petits laboratoires de pâtisserie, glaciers et pizzerias**. Il permet de laver jusqu'à 4 plateaux de pâtisserie simultanément.

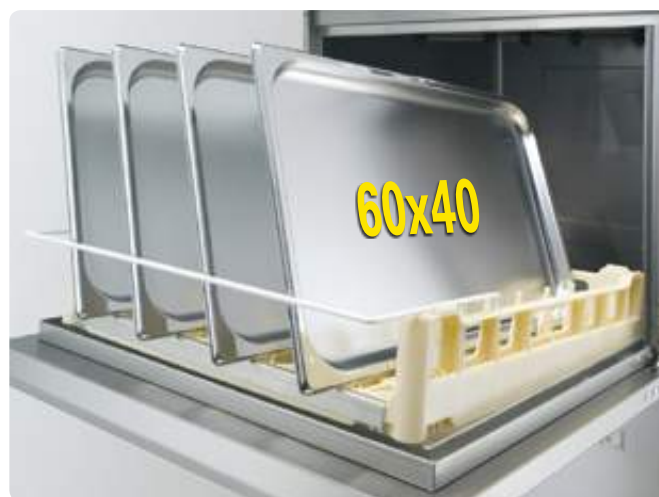

Smart dispenser. Reduced detergent consumption thanks to the smart dispenser (optional) and their probes which pours the correct quantity of detergent according to the needs.

Smart dispenser. Consumi ridotti di detersivo, grazie al dosatore intelligente (optional) che, tramite dei sensori, immette il giusto quantitativo di detersivo in base al livello di sporco.

Dosage intelligent. Réduction de la consommation de détergent, grâce à un dispositif intelligent (en option) qui "capte" le niveau de saleté et ne diffuse que la quantité nécessaire.



I-wash system: it gives the possibility to adapt the cycle and the wash temperature based on the kind of dirt and to the ware to be washed, so that the result can be always impeccable.

I-wash system: Possibilità di ottimizzare la durata e la temperatura di lavaggio in base al tipo di sporco e agli oggetti da lavare, per un risultato sempre impeccabile.

I-wash system: Possibilità d'optimiser la durée et la température de lavage en fonction du type de saleté et les ustensiles à laver, pour un résultat toujours impeccable.



BEST WASH!

Lavaggio impeccabile • Lavage impeccable



ALP 43

Ideal for bread baskets 60x40 cm

Indicato per ceste pane 60x40 cm
Indiqué pour paniers à pain 60x40 cm



60x40 max



64



57x57



30-15

The model ALP 43 is ideal in **bakeries, supermarkets and butcher's shops**. It can wash **pots and trays up to 60 cm**.

ALP 43 è la lavastoviglie ideale per le panetterie, supermercati e macellerie. Permette di lavare pentole e teglie grandi fino a 60cm.

ALP 43 est idéal pour **boulangeries, supermarchés et boucheries** pour laver des **casseroles et des plaques grandes jusqu'à 60 cm**.



2 boilers guarantee that the average rinsing temperature is always kept above 80°C, more effective against the bacteria.

2 boiler garantiscono una temperatura media di risciacquo più alta e sempre superiore agli 80°C, più efficace contro i batteri.

Deux surchauffeurs assure de maintenir une température de rinçage plus haute et toujours supérieure à 80°C, plus efficace contre les bactéries.



Double stainless steel surface filters in the tank with a removable basket for collecting solid waste.

Doppi filtri inox differenziati in vasca con cestello separato per la raccolta dei rifiuti solidi.

Doubles filtres en inox différenciés dans la cuve avec un bac distinct pour la collecte de déchets solides.



3 wash arms of stainless steel for a long durability. Particularly shaped jets for keeping them free from solid waste.

Bracci di lavaggio in inox a 3 razze per la massima durabilità. Particolare configurazione degli ugelli che li rende inostruibili.

Système de lavage à 3 bras en inox pour une meilleure durabilité. Configuration particulière ds jets qui empêche leur obstruction.



HYGIENE GUARANTEED

Igiene garantita • Hygiène garantie



ALP 01

For trays up to 80 cm (model ALP 01 S)

Per teglie fino a 80 cm (versione S)

Pour plaques jusqu'à 80 cm (mod. ALP 01 S)



80 max



64-85



64-85



60x70



30-15

This model represents the ideal solution for washing backing trays up to 80 cm in **bakeries, patisseries and supermarkets**.

*Il modello ALP 01 rappresenta la migliore soluzione per quei **panifici, supermercati** e per tutti i laboratori di preparazione degli alimenti nei quali sia necessario lavare teglie fino a 80 cm.*

Ce modèle convient parfaitement aux boulangeries, **supermarchés et aux grands laboratoires** pour la préparation des aliments. Il permet de laver des plaques allant jusqu'à 80 cm.

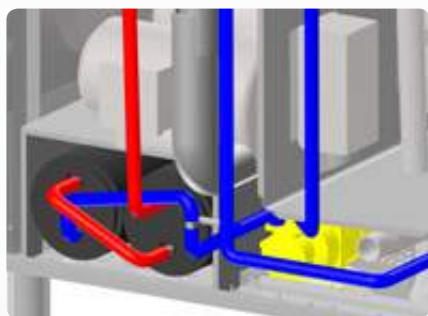

W.A.G.P. System. Excellent washing results with the booster pump. Thanks to the break tank, racks and pots are washed at the right water capacity.

W.A.G.P. System. Eccellenti risultati di lavaggio grazie alla pompa di aumento pressione. La break tank integrata permette un lavaggio di pentole e cesti con la giusta portata d'acqua.

W.A.G.P. System. D'excellents résultats de lavage grâce à la pompe de surpression. Le réservoir intégré 'break tank' permet le lavage des ustensils et des paniers avec le débit d'eau correct.



35% more powerful. ALP 01 has 2 independent wash pumps, while similar products of the competitors have 1 pump only.

+35% di potenza. ALP 01 monta 2 pompe di lavaggio indipendenti, contro 1 dei concorrenti, per una performance ineguagliabile.

+ 35% de puissance. ALP 01 a 2 pompes de lavage indépendantes, tandis que les concurrents ont une pompe seulement.





N°1 WASHING

Lavaggio N°1 • Le N° 1 du lavage



ALP 01 S



ALP 01 GS



ALP 02

For 3 baskets 60x40 cm

Contiene fino a 3 cesti 60x40 cm.

Possibilità di lavare jusqu'à 3 paniers 60x40 cm



80 max



3x(60x40)



64-85



132x60



30-15

ALP 02 is the dishwasher suitable for **cooking centers, canteens and hospitals** that require a large washing capacity. Thanks to its basket of large dimensions, ALP 02 can hold up to **three bread baskets at the same time**.

ALP 02 è la lavastoviglie indicata per i centri di cottura, mense ed ospedali dove è richiesta una elevata capacità di lavaggio. Grazie al suo cesto di grande dimensioni, ALP 02 può contenere fino a 3 ceste pane contemporaneamente.

ALP 02 le lave-vaisselle est indiqué pour les **laboratoires de cuisson, cantines et hôpitaux** qui nécessitent une grande capacité de lavage. Grâce aux dimensions du panier, ALP 02 peut contenir jusqu'à **trois paniers à pain simultanément**.



Extreme power. Three independent wash pumps for the upper and lower washing, compared to the 2 of the competitors, provide a greater washing power of 25%.

Potenza al cubo. Le 3 pompe di lavaggio indipendenti per il lavaggio inferiore e superiore, rispetto alle 2 dei concorrenti, forniscono una potenza di lavaggio maggiore del +25%.

Puissance au cube. Les 3 pompes de lavage pour le lavage supérieur et inférieur, comparativement aux 2 des concurrents, donnent une puissance supérieure de 25%.



TRIPLE POWER

Potenza al cubo • Puissance au cube



ALP 02 GS



ALP 02 S



ALC 100

Automatic rack conveyor

Trascinamento cesti automatico.
Avancement automatique des casiers.



60x40



68x50



100



Programmable
000

Powerful in washing and quick in loading and unloading, the ALC 100 is the ware washer more suitable for users who require **maximum productivity**.

Potente nel lavare e veloce da caricare e scaricare, la ALC 100 è la lavastoviglie più indicata per le utenze che richiedono la massima produttività.

Puissant dans le lavage et rapide à charger et décharger, l'ALC 100 est le lave-ustensils le plus approprié pour les utilisateurs qui exigent une **productivité maximale**.



Little space required thanks to its overturning system. To load and unload the racks are the only things the operator has to do.

Il sistema di ribaltamento delle ceste permette un ingombro ridotto. È possibile effettuare il carico/scarico dei cesti con un solo operatore.

Le système de basculement des paniers permet un encombrement minimal. Il est possible d'effectuer le chargement / déchargement des paniers par un seul opérateur.



Three-way washing system: from the upper part, from the lower part and from the sides. That allows a **better cleaning of the racks**. Washing racks **different in dimensions** thanks to its central rack conveyor system.

Il sistema di lavaggio tri-direzionale, con getti inferiori, superiori e laterali, consente una migliore pulizia dei cesti. Il sistema di trascinamento centrale permette di lavare ceste di dimensioni diverse.

Le système de lavage à trois dimensions: supérieur, inférieur et latéral **permet de laver mieux les casiers**. Possibilité de laver de **casiers de différentes dimensions** grâce au système d'avancement central.



The independent wash and rinse tanks and the double rinsing optimize the performance and together with the rinse water economizer supplied as standard **keep the consumption low**.

Le vasca di lavaggio e di risciacquo indipendenti e il doppio risciacquo ottimizzano le prestazioni e, abbinate all'economizzatore dell'acqua di risciacquo fornito di serie, mantengono bassi i consumi.

Les cuves de lavage et de rinçage indépendants et le double rinçage optimisent la performance et, combinée avec économiseur de l'eau de rinçage fourni en standard, **réduisent la consommation d'énergie**.





RECORD SPEED 100 BASKET/H

Ultra rapida. 100 cesti/h • Ultrarapide. 100 panier/h





www.atasrl.com

Cooking equipment

Professional dishwashers

ATA srl

Viale del Progresso, 20 - ZI - 35026 Conselve (Padova) - Italy

Tel. +39 049 9500555 - Fax. +39 049 9500560 - mail@atasrl.com





Rack-conveyor dishwashers

Lavastoviglie a cesto trainato
Lave-vaisselle à avancement
automatique de paniers



www.atasrl.com



Professional dishwashers



To trust in an efficient washing system is one of the most important things for restaurateurs. In this way they can stay focused on what really matters: taking care of their customers and offering a good quality service.

To achieve results without compromise – even in complex scenarios such as cooking centres, hotels and canteens – ATA designed the most innovative technical solutions that have become the standard solutions in the whole range of rack-conveyor dishwashers.

La certezza del risultato

Poter contare su un efficace sistema di lavaggio è fondamentale per un ristorante. Solo in questo modo può infatti concentrarsi su ciò che ama di più: la cura dei propri clienti e la qualità della propria cucina.

Perciò ATA non soltanto ha progettato le soluzioni tecniche più all'avanguardia, ma le ha incluse come standard in tutta la gamma delle lavastoviglie a traino, per ottenere un risultato senza compromessi anche in ambienti complessi come i centri di cottura, gli hotel e le mense.

ATA Rack-conveyor dishwashers Be confident in washing results



Le résultat sans aucun doute

Compter sur un système efficace de lavage il est de la plus grande importance à un traiteur. Seulement de cette manière il peut se concentrer sur ce qu'il aime le plus: le soin de ses clients et la qualité de sa cuisine.

Donc ATA a conçu les solutions techniques les plus avancées, qui sont devenues des standards sur toute la gamme des lave-vaisselle à avancement automatique de casiers; le résultat est sans compromis, même dans des environnements complexes tels que les centres de cuisson, hôtels et cantines.



1 Reduced energy consumption

2 Excellent was performance



Three simple reasons for choosing **ATA**

*Tre semplici ragioni per scegliere **ATA***
Trois simples raisons pour choisir **ATA**



1. Reduced energy consumption

Running costs are dramatically reduced thanks to a number of solutions for reducing the consumption of water, energy and detergent.

1. Minor consumo energetico

I costi di gestione sono ridotti al minimo grazie alle numerose soluzioni pensate per ridurre il consumo d'acqua, di energia e di detersivo.

1. La plus bas consommation d'énergie

Les coûts de fonctionnement sont réduits au minimum grâce aux nombreuses solutions visant à réduire la consommation d'eau, d'énergie et de détergent.

hing

3 100% personalized



2. Excellent washing performance

The complete personalization of the washing cycles, the double-rinse system for the all ATR range and the double-boiler water heating system are examples of the technical solutions for washing up to 5,000 dishes per hour.

2. Le migliori prestazioni di lavaggio

Cicli di lavaggio completamente personalizzabili, un doppio risciacquo di serie ed il sistema di riscaldamento a doppio boiler sono solo alcune delle soluzioni tecniche che permettono di lavare più di 5000 piatti all'ora.

2. Meilleure performance de lavage

Les cycles de lavage entièrement personnalisables, le double rinçage sur toute la gamme et le système de chauffage avec un double surchauffeur sont que quelques exemples des solutions techniques qui permettent de laver plus de 5000 assiettes par heure.

3. 100% Personalized

Rack-conveyor dishwashers are extremely flexible thanks to washing and drying modules of different dimensions, available in both straight and corner versions, and to a number of entry and exit tables. They can easily optimize the work flow and adapt to every kitchen.

3. A personalizzazione al 100%

I moduli di lavaggio e di asciugatura di diverse dimensioni, disponibili nelle versioni in linea o ad angolo, si abbinano ai numerosi tavoli di ingresso e uscita per ottimizzare i flussi e adattarsi ad ogni ambiente.

3. Personnaliser au 100%

Les modules de lavage et de séchage avec de dimensions différentes, disponibles dans les versions en ligne ou en angle, peuvent être combinés avec les nombreuses tables d'entrée et de sortie pour optimiser le flux de production et s'adapter à tout environnement.



1 Reduced energy consumption



REDUCED WATER CONSUMPTION BY 50%*

ATA double-rinse system ensures both perfect washing results for your dishes and glasses and water savings. The pre-rinse stage reuses water coming from the second rinse area and, thanks to a pump, directs it towards the crockery at the right pressure.

50% DI CONSUMO D'ACQUA*

Il sistema di risciacquo doppio di ATA garantisce un miglior risultato sulle stoviglie risparmiando acqua allo stesso tempo. Il pre-risciacquo riutilizza l'acqua proveniente dal secondo stadio e, attraverso una pompa, la indirizza sulle stoviglie sempre alla giusta pressione.

50% DE CONSOMMATION D'EAU*

Le système de rinçage en deux fois de ATA garantit un meilleur résultat et permet d'économiser l'eau en même temps. La première partie du rinçage réutilise l'eau provenant de la deuxième et, par l'intermédiaire d'une pompe, dirige l'eau sur la vaisselle en gardant toujours la bonne pression.

*Starting from mod. ATR 2700 - A partire dal mod. ATR 2700 - À partir du mod. ATR 2700.



ATR 3800 ES

WHAT IS NEEDED WHEN IT IS NEEDED

An energy economizer stops the water flow, the pump functioning and the automatic dragging system when no baskets are entering into the dishwasher. In stand-by mode your dishwasher wastes neither water nor energy.

QUANDO SERVE & QUANTO SERVE

Un economizzatore di energia blocca il flusso d'acqua, il funzionamento delle pompe e il sistema automatico di avanzamento quando non vengono inseriti i cesti. In modalità di stand-by la lavastoviglie non spreca quindi acqua ed energia.



COMBIEN ET QUAND IL EST NÉCESSAIRE

Une économie d'énergie arrête la circulation d'eau, le fonctionnement des pompes et le système automatique d'avancement lorsque les paniers ne sont pas situés à l'intérieur. En mode veille, il n'y a pas de consommation d'eau et d'énergie.



1 Reduced energy consumption



ATR 1500

REDUCED DETERGENT CONSUMPTION BY 50%**

Starting from mod. ATR 2700, ATA modular dishwashers have an independent tank for pre-washing, which is carried out with colder water. In this way you will experience better washing results even against encrusted starch and proteins. Detergent will be dissolved only in the water for washing and your savings will be increased up to 50%**.

-50% DI CONSUMO DI DETERSIVO**

*Le lavastoviglie modulari ATA (a partire dal mod. ATR 2700) hanno una vasca indipendente per il prelavaggio, che in questo modo avviene ad acqua più fredda. Si ottiene così un miglior risultato anche contro le incrostazioni di amido e proteine. Il detersivo verrà disciolto solo nell'acqua di lavaggio, con un risparmio fino al 50%**.*



-50% DE CONSOMMATION DE DÉTERGENT**

Les lave-vaisselle modulaires ATA (à partir de mod. ATR 2700) sont composés d'une cuve de pré-lavage indépendante avec une température inférieure. De cette façon on peut avoir un meilleur résultat aussi contre les incrustations d'amidon et de protéines. Le détergent sera que dans l'eau de lavage, avec une économie jusqu'à 50%**.

**Value calculated on mod. ATR 3200 - Valore calcolato sul mod. ATR 3200 - Valeur calculée sur le mod. ATR 3200.



WOULD YOU LIKE TO SAVE UP TO 4,200 EURO/YEAR**?**

Yes, it is possible thanks to ATA steam condenser with heat recovery mod. HR – available on demand (option) –, a device collecting steam for pre-heating inlet water. A green solution and an investment that pays for itself in about one year.

VUOI RISPARMIARE FINO A 4200€/ANNO**?**

È possibile grazie al sistema di condensa fumane HR (optional) di ATA, che permette di recuperare il calore del vapore per preriscaldare l'acqua di ingresso. Una soluzione ecologica e un investimento che si ripaga in poco più di un anno.

VOULEZ VOUS ÉCONOMISER JUSQU'À 4200 € / AN**?**

Il est possible grâce au système de condensation des buées HR (en option), qui permet de récupérer la chaleur de la vapeur pour préchauffer l'eau à l'entrée. Une solution écologique et un investissement qui paie pour lui-même sur une année environs.



DON'T WORRY, DON'T WASTE

Increased detergent savings if provided with ATA Smart Dispenser, a smart dosing system – available on demand (option) – that “feels” the dirt and pours in only the needed detergent when it is needed.

AUCUN SOUCI, AUCUN DÉCHET

Encore plus économique à l'usage si combinée avec le Smart Dispenser ATA, le système de dosage de détergent intelligente (option), qui analyse le degré de saleté et distribue uniquement la quantité correspondante.

NESSUN PENSIERO, NESSUNO SPRECO

Ancora più economica nella gestione se abbinata allo Smart Dispenser ATA, il sistema di dosaggio intelligente del detersivo (optional), che ‘sente’ lo sporco e ne immette solo la quantità necessaria.



CAREFUL WITH YOUR WORKING ENVIRONMENT

The double-skinned structure of tanks, doors and top of the dishwasher imply lower loss of heat in your working environment. Insulated boilers achieve additional energy savings****.

ATTENTION AU ENVIRONNEMENT

La structure à double paroi de la cuve, des portes et du toit protège contre la perte de chaleur dans l'environnement. L'isolation de la porte du surchauffeur permet des économies d'énergie supplémentaires****.

ATTENTA ALL'AMBIENTE DI LAVORO

La struttura in doppia parete della vasca, delle porte e del tetto della macchina permette minori dispersioni del calore nell'ambiente di lavoro. L'isolamento dei boiler consente un ulteriore risparmio energetico****.

*** Temperature of inlet water at 10°C. Dishwasher functioning for 6 hours a day for 365 days/year at an average loading capacity of 80%. Energy cost at 0.2 EURO/kWh.
 Temperatura acqua in ingresso 10°C. Funzionamento di 6 ore al giorno per 365 giorni/anno, con la lavastoviglie caricata in medio per l'80%. Costo dell'energia 0,2€/kWh.
 Température de l'eau à l'entrée de 10°C. Fonctionnement de six heures par jour, 365 jours/an, de un lave-vaisselle chargé en moyenne de 80%. Coût de € 0,2 / kWh.

****Starting from mod. ATR 3200 - A partire dal mod. ATR 3200 - À partir du mod. ATR 3200



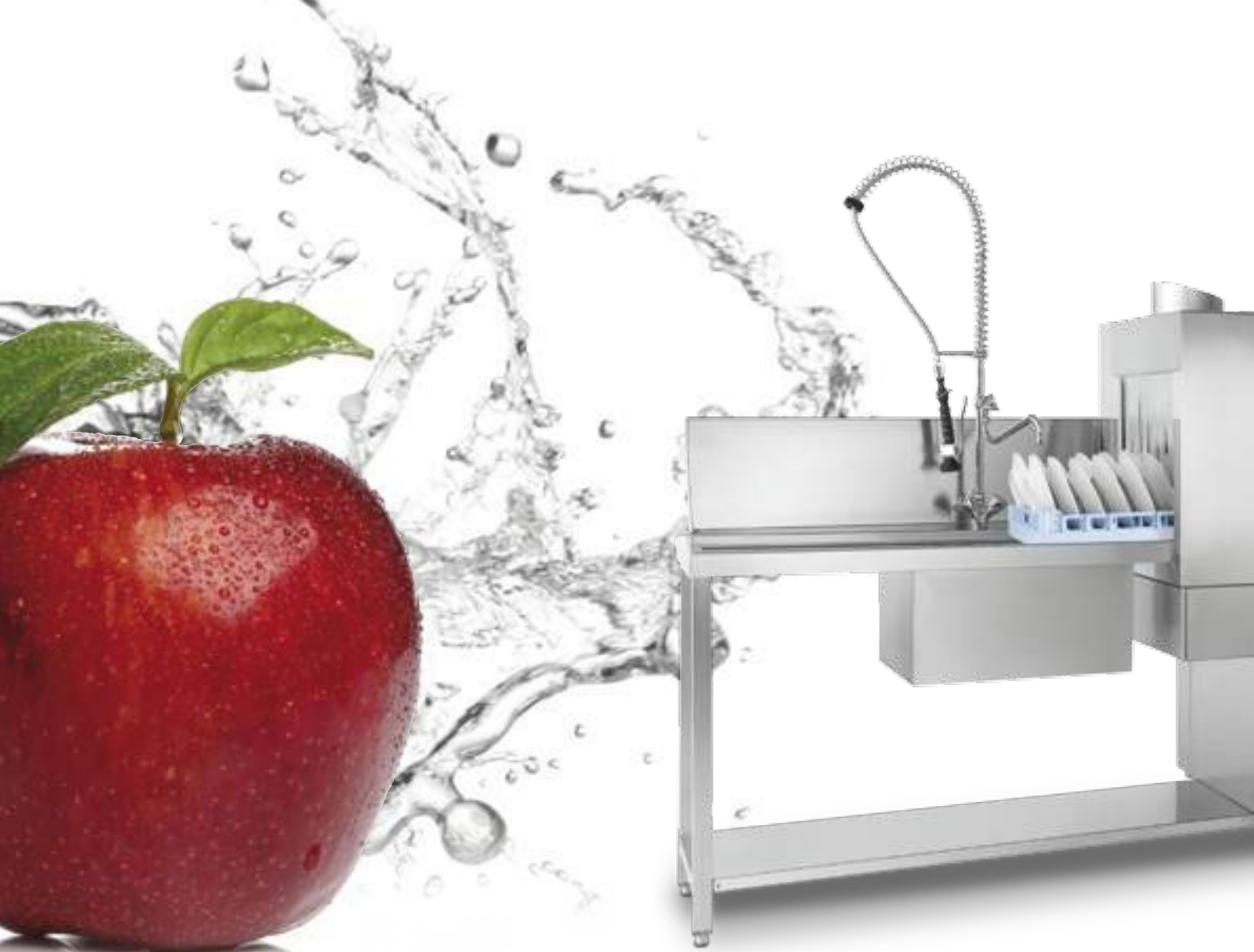

2 Excellent washing performance



TAILOR-MADE WASHING SOLUTIONS

Thanks to a digital control panel, ergonomically placed and intuitive to use, you can optimize the washing length and temperatures according the type of dirt and what is to be cleaned for brilliant, shiny results.

LE MIGLIORI PRESTAZIONI DI LAVAGGIO

Tramite il pannello di comandi digitale, ergonomicamente posizionato e intuitivo nell'utilizzo, è possibile ottimizzare la durata e la temperatura di lavaggio in base al tipo di sporco e agli oggetti da lavare, per un risultato sempre impeccabile.

UN LAVAGE SUR MESURE

À travers le panneau de commande à affichage, ergonomiquement positionné et intuitif à utiliser, vous pouvez optimiser la durée et la température de lavage en fonction du type de saleté et des objets à laver, pour un résultat impeccable.

Three simple reasons for choosing **ATA**



ATR 3800 AVS

EXCELLENT RESULTS

Perfect rinsing results are achieved thanks to the W.A.G.P. (up the mod. ATR 1800), a built-in water reserve with pump ensuring constant water pressure and capacity, no matter what the inlet water pressure may be.

RISULTATI ECCELLENTI

Risciacquo perfetto con W.A.G.P. (fino a mod. ATR 1800): il sistema che, con una vasca ed una pompa addizionali, fornisce la giusta pressione e portata d'acqua indipendentemente dai valori di rete.

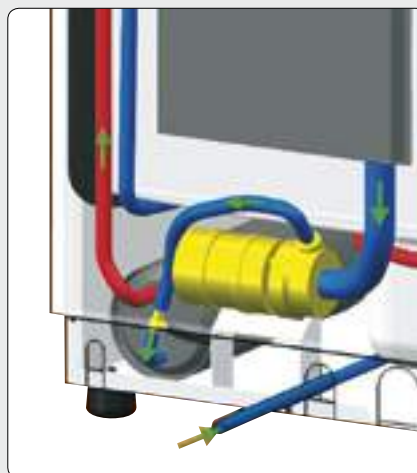

RÉSULTATS PARFAITS

Rinçage parfait avec le W.A.G.P. (jusqu'au mod. ATR 1800): Le système qui, avec un réservoir et une pompe supplémentaire, apporte la pression correcte et le débit de l'eau indépendamment des valeurs du réseau.



2 Excellent washing performance



SUREFIRE HYGIENE

During the rinsing cycle an additional boiler keeps the average water temperature always above 80°C for dramatically reducing the bacterial load.

IGIENE GARANTITA

Un boiler aggiuntivo garantisce una temperatura media di risciacquo più alta e sempre superiore agli 80° C, a garanzia della rimozione della carica batterica.

HYGIÈNE GARANTIE

Un surchauffeur supplémentaire assure une température moyenne de rinçage plus haute et toujours supérieure à 80 ° C, afin de garantir l'élimination de la charge bactérienne.



OPTIMIZED WASHING CIRCUIT

The water flow is not blocked during the washing cycle thanks to the dragging system with side rails: it is designed for improving the lower washing and cleaning glasses, cups and pots deeply.

CIRCUITO DI LAVAGGIO OTTIMIZZATO

Il sistema di trascinamento con guide laterali è stato progettato per non creare ostacoli al libero flusso dell'acqua ed ottenere un lavaggio inferiore migliore per la pulizia di bicchieri, tazze e pentole.

CIRCUIT DE LAVAGE OPTIMISÉ

Le système d'entraînement avec glissières latérales est conçu pour ne pas créer des obstacles à la circulation de l'eau et pour un résultat de lavage inférieure meilleur en cas des verres, tasses et des pots.



CLEANER WATER

You can easily and quickly take out and clean the surface filtration system. The pre-washing, washing and rinsing areas are characterized by independent tanks and water circuits (starting from the mod. ATR 2700). You will then experience more efficient washing performance and reduced needs of water draining and refilling, because it is not affected by solid waste in the pre-washing area.

ACQUA PIÙ PULITA

Il sistema di filtrazione superficiale è semplice da estrarre e veloce da pulire. Le zone di pre-lavaggio, lavaggio e risciacquo separate con vasche e circuiti idrici indipendenti (a partire dal mod. ATR 2700) permettono un lavaggio più efficace e una minore necessità di ricambio d'acqua, che non risente dello sporco pesante del prelavaggio.

EAU PLUS PROPRE

Le système de filtration de surface est simple à extraire et rapide à nettoyer. Les zones de pré-lavage, lavage et de rinçage avec des cuves et des circuits d'eau indépendantes (à partir du mod. ATR 2700) permet un nettoyage plus efficace et de remplacer d'eau moins souvent, car elle n'est pas affectée par la saleté du pré-lavage.

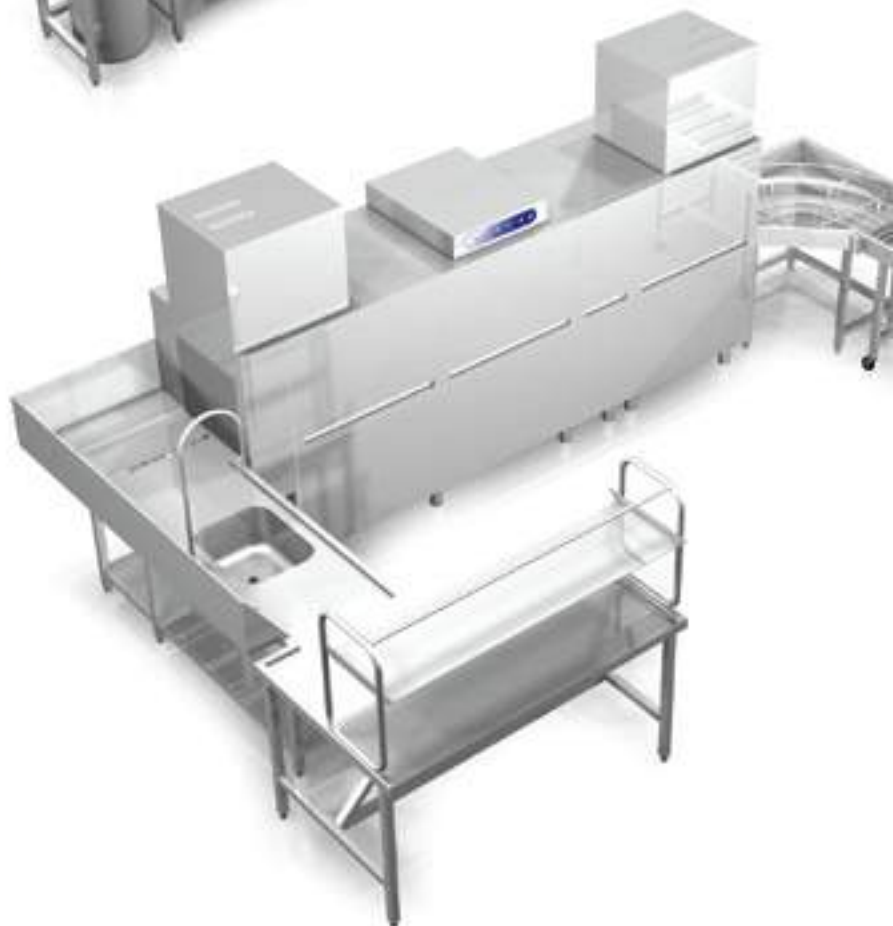

3 100% personalized

Thanks to washing and drying modules of different dimensions and to a number of entry and exit tables, each dishwashing area is developed as a unique, personalized project. You can choose among:

Grazie alle numerose soluzioni disponibili nei moduli di lavaggio e nei tavoli proposti, ogni lavastoviglie viene progettata individualmente. È possibile costruire un layout della zona di lavaggio personalizzato, potendo scegliere tra:

Grâce aux nombreuses solutions disponibles dans les modules de lavage et de tables, chaque lave-vaisselle est conçu individuellement. Vous pouvez construire un projet personnalisé de la zone de lavage et de choisir entre:



Straight or corner washing units of different dimensions.

Unità di lavaggio in linea o ad angolo, di varie dimensioni.

Unités de lavage en ligne ou d'angle, de différentes dimensions.

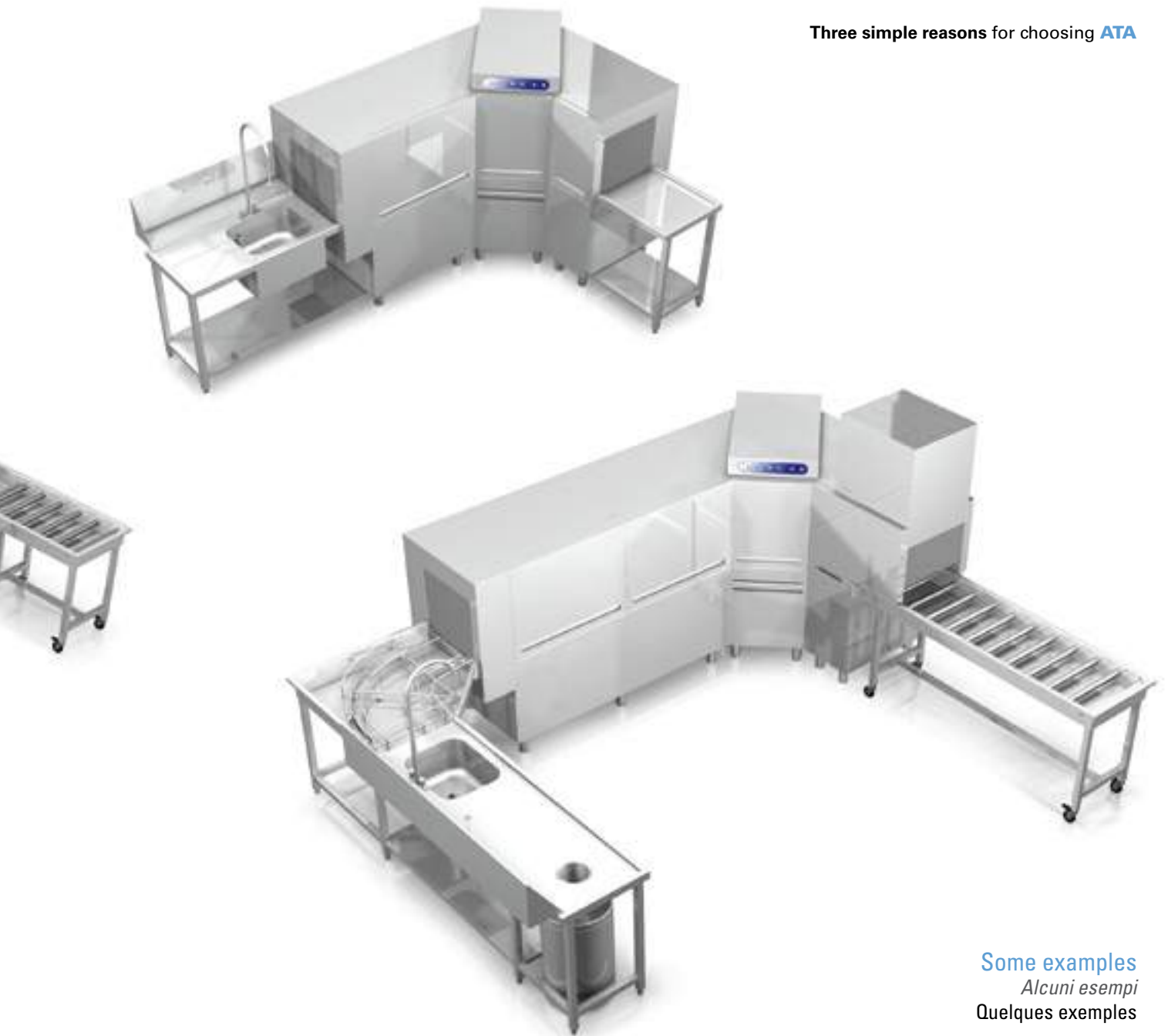

Some examples
Alcuni esempi
Quelques exemples



Simple or with heat recovery steam condenser units and different drying tunnels.

Unità per condensa fumane, anche con recupero di calore, e diverse zone di asciugatura.

Unité de condensation des buées, même avec récupération de la chaleur, et les différentes zones de séchage.



Simple or mechanized entry tables with sorting shelf and pre-washing area.

Tavoli di ingresso con un'area per la cernita e il prelavaggio anche con movimentazione meccanizzata.

Tables avec zone d'entrée pour le tri et le pré-lavage avec mouvement mécanisé aussi.



Simple or roller conveyor exit tables.

Tavoli di uscita semplici o a rulli folli

Tables de sortie simples ou avec rouleaux.



ATA The importance of details

- Basket side rails for preventing the water flow from being blocked during the washing cycle: brilliant results.
- Bayonet plugs for quick dirt removal from washing machine arms
- Two independent energy economizers, one in the washing area and the other in the rinsing area.
- IPX5 waterproof standard for extremely easy cleaning.

L'IMPORTANZA DEI DETTAGLI

- *Guide cesti laterali per non creare ostacoli al flusso dell'acqua ed ottimizzare il lavaggio.*
- *Chiusure dei bracci a baionetta per rimuoverne lo sporco velocemente*
- *2 economizzatori di energia indipendenti nella zona di lavaggio e di risciacquo*
- *Grado di protezione dall'acqua IPX5. Massima facilità di pulizia.*

L'IMPORTANCE DES DÉTAILS

- *Glissières latérales des paniers pour ne pas créer des obstacles à la circulation de l'eau et pour un résultat de lavage impeccable.*
- *Fermetures à baïonnette pour nettoyer les bras rapidement.*
- *2 économiseurs d'énergie indépendants dans la zone de lavage et de rinçage.*
- *Indice de protection de l'eau IPX5. Facile à nettoyer.*



Rack exit

Uscita cesti
Sortie paniers

Wash

Lavaggio
Lavage

Rinsing

Risciacquo
Rinçage

Drying

Asciugatura
Sechage



Sturdy structure entirely made of stainless steel up to 3 mm.

Robusta struttura, interamente in acciaio inox fino a 3mm di spessore.

Structure robuste, entièrement en acier inoxydable jusqu'à 3 mm d'épaisseur.



Easy to remove washing arms for quick cleaning.

Bracci di lavaggio facilmente asportabili per una più agevole pulizia.

Les bras de lavage peuvent être facilement enlevés pour un nettoyage facile.



Double-boiler system for rinsing water always above 80°C.









Doppio boiler per un'acqua di risciacquo sempre superiore agli 80°C.

Double surchauffeur pour avoir l'eau de rinçage toujours supérieure à 80°C.

ATA Tips for choosing your ideal dishwasher

L'importanza della giusta scelta - Indication à la choix du modèle

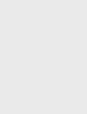
MODELS MODELLI MODÈLES		ATR 1500	ATR 1800	ATR 2700	ATR 2700V	ATR 3200	ATR 3200V	ATR 3800	ATR 3800V		
ICON ICONA ICÔNE											
DIMENSIONS DIMENSIONI DIMENSIONS		X (mm)	1200	1400	1570	1870	2170				
		Y (mm)	1380	1380	1580	1580	1580				
		Z (mm)	720	720	800	800	800				
PRODUCTION PRODUZIONE PRODUCTION		Baskets/h Cesti/h Paniers/h	85	100	80	90	110				
					115	135	160				
					150	180	210				
PRE-WASH PRELAVAGGIO PRE-LAVAGE		kW				1,0	1,0				
		l				45	45				
1st WASH 1° LAVAGGIO 1ère LAVAGE		kW	1,5	1,5	2,2	1,0	2,2				
		l	55	55	85	45	85				
		kW	Hot water 50°C	4,5	4,5	6,0	/	6,0	/	6,0	/
			Cold water 20°C	9,0	9,0	9,0	/	9,0	/	9,0	/
2nd WASH 2° LAVAGGIO 2ème LAVAGE		kW									
		l									
		kW	Hot water 50°C								
			Cold water 20°C								
RINSE RISCIAQUO RINÇAGE		kW	0,4	0,4	0,4	0,4	0,4				
		l	/	/	12	12	12				
		kW	Hot water 50°C	15,0	18,0	18,0	/	18,0	/	18,0	/
			Cold water 20°C	24,0	24,0	24,0	/	24,0	/	24,0	/
		l		8 + 8	8 + 8	10 + 10	10 + 10	10 + 10			
				290	290	330	330	330			
INSTALLED POWER POTENZA TOTALE PUISSANCE TOTALE	Hot water 50°C	kW	17,1	20,1	27,3	3,3	27,1	3,1	28,3	4,3	
INSTALLED POWER POTENZA TOTALE PUISSANCE TOTALE	Cold water 20°C	kW	29,6	30,6	36,3	3,3	36,1	3,1	37,3	4,3	
TOTAL POWER WITH HEAT RECOVERY POTENZA TOTALE CON RECUPERO CALORE PUISSANCE TOTALE AVEC RÉCUPÉRATION DE CHALEUR	Cold water 20°C	kW	/	/	33,3	3,3	33,1	3,1	34,3	4,3	
DRYING ASCIUGATURA SÈCHAGE		m³/h	AZ 75	1700	AZ 80 AZ 81 AZ 85	1700					
		kW		6,75		9,75					
STEAM OUTPUT CONSUMO VAPORE CONSOMMATION VAPEUR		kg/h	/	/	/	50	/	50	/	50	

	ATR 4300	ATR 4300V	ATR 4900	ATR 4900V	ATR 5400	ATR 5400V	ATR 2700A	ATR 2700AV	ATR 3200A	ATR 3200AV	ATR 3800A	ATR 3800AV	ATR 4300A	ATR 4300AV	
															
	2470		3070		3370		1420		2320		2920		3220		
	1580		1580		1580		1580		1580		1580		1580		
	800		800		800		1590		1590		1590		1590		
	140		160		190		80		90		110		140		
	190		215		245		115		135		160		190		
	240		270		300		150		180		210		240		
	2,2		1,0		2,2				2,2		1,0		2,2		
	85		45		85				85		45		85		
	2,2		2,2		2,2		1,0 + 1,0		1,0 + 1,0		2,2		2,2		
	85		85		85		100		100		85		85		
	6,0	/	6,0	/	6,0	/	9,0	/	9,0	/	6,0	/	6,0	/	
	9,0	/	9,0	/	9,0	/	9,0	/	9,0	/	9,0	/	9,0	/	
			2,2		2,2						1,0 + 1,0		1,0 + 1,0		
			85		85						100		100		
			6,0	/	6,0	/					9,0	/	9,0	/	
			9,0	/	9,0	/					9,0	/	9,0	/	
	0,4		0,4		0,4		0,4		0,4		0,4		0,4		
	12		12		12		12		12		12		12		
	18,0	/	18,0	/	18,0	/	18,0	/	18,0	/	18,0	/	18,0	/	
	24,0	/	24,0	/	24,0	/	24,0	/	24,0	/	24,0	/	24,0	/	
	10 + 10		10 + 10		10 + 10		10 + 10		10 + 10		10 + 10		10 + 10		
	330		330		330		330		330		330		330		
	29,5	5,5	36,5	6,5	37,7	7,7	30,1	3,1	32,3	5,3	39,3	6,3	40,5	7,5	
	38,5	5,5	48,5	6,5	49,7	7,7	36,1	3,1	38,3	5,3	48,3	6,3	49,5	7,5	
	35,5	5,5	45,5	6,5	46,7	7,7	33,1	3,1	35,3	5,3	45,3	6,3	46,5	7,5	
STEAM ASPIRATION ASPIRAZIONE FUMANE ASPIRATION BUÉES		kW	0,75				GEAR MOTOR POWER POTENZA MOTORIDUTTORE PUISSANCE MOTOREDUCTEUR		MOTOR		kW	0,25			
/	50	/	50	/	50	/	50	/	50	/	50	/	50	/	



www.atasrl.com

Cooking equipment

Professional dishwashers

ATA srl

Viale del Progresso, 20 - ZI - 35026 Conselve (Padova) - Italy

Tel. +39 049 9500555 - Fax. +39 049 9500560 - mail@atasrl.com

